

AQUARIUS

Modular single-jet cold or hot water meter
with magnetic transmission
DN 15 and 20 mm

Aquarius is a domestic water meter designed for measuring consumption of cold or hot water in housing blocks.

It has class B EEC approval for use in the horizontal position and class A approval for the vertical position. Magnetic transmission is used to isolate the register from the hydraulic part, and the register swivels to ensure easier index reading. Aquarius belongs to the Sappel modular range and may be fitted, even after it is installed, with a Pulsar pulse transmitter to connect with the Izar radio reading systems, the Draco dosing devices or the Cursa consumption analysers.

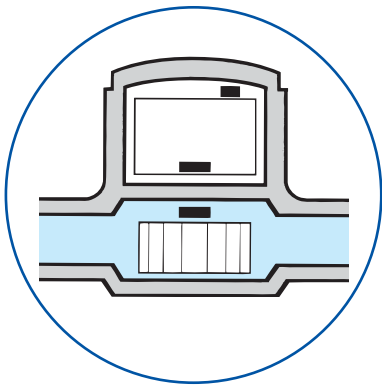

water range



modularity

 **sappel**

Main technical characteristics

DESIGNATION









Aquarius

Calibration DN	mm	15				20			
Installation		Horizontal		Vertical		Horizontal		Vertical	
		Cold	Hot	Cold	Hot	Cold	Hot	Cold	Hot

MEASURING RANGE (m³/h)

Minimum flowrate	Q _{min.}	0.03	0.06	0.05	0.1
Transition flowrate	Q _t	0.12	0.15	0.2	0.25
Nominal flowrate	Q _n	1.5		2.5	
Maximum flowrate	Q _{max.}	3		5	

EEC APPROVAL

Class	B		A		B		A	
Approval number								

TEMPERATURES AND PRESSURE

Max. t.	°C	30	90	30	90	30	90	30	90
Max. service pressure		16 bar							

HEAD LOSS

Kvs (Δ P=Q ² /Kvs ²)	3.12				5			
---	------	--	--	--	---	--	--	--

DIMENSIONS, WEIGHT AND CONNECTIONS

Length	mm	80 o 110*				130			
Width	mm	90				90			
Height/centre line h	mm	64				57			
Total height H	mm	77				74			
Threaded connectors	G	3/4"*				1"			
Weight	Kg	0.46				0.58			

*Other lengths and connections on demand.

DIMENSIONS

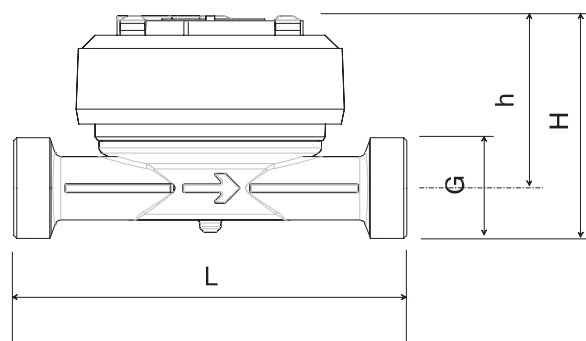

Precision curve

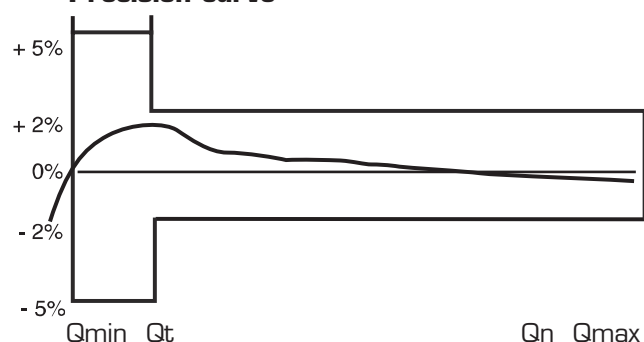

Optional : Pulse emitter
Pulsar : 1 pulse/litre

Distributed by :



Freephone : 0800 353 966

If you have any question, please do not hesitate to contact us :



HEAD OFFICE B.P. 10160 - 67 rue du Rhône - 68304 Saint-Louis Cedex - France
Tel. +33 (0)3.89.69.54.00 - Fax +33 (0)3.89.69.72.20
Web: www.sappel.com - E-mail: info@sappel.com

EXPORT B.P. 10160 - 67 rue du Rhône - 68304 Saint-Louis Cedex - France
Tel. +33 (0)3.89.69.54.21 - Fax +33 (0)3.89.69.54.22
E-mail: export@sappel.com