

# Battery-Powered Controllers

*Full-Featured Controllers for Landscape Sites  
Without a Readily-Accessible Electrical Power Supply*



Auckland NZ  
PH: (09) 919 7600  
FAX: (09) 919 7604

Distributed by: **aquaspec**  
www.aquaspec.co.nz 0800 353 966

Christchurch NZ  
PH: (03) 968 3230  
FAX: (03) 968 3231

## TABLE OF CONTENTS

<b>Applications for Battery-Powered Controllers .....</b>	<b>1</b>
<b>Smart Valve Controller (SVC)</b>	
Product Overview .....	2
Product Features and Benefits .....	2
Product Comparisons.....	8
Product Components.....	9
Installation .....	10
Programming .....	12
Troubleshooting .....	17
Technical Information.....	17
Product Explanation.....	17
<b>Wireless Valve System</b>	
Product Overview .....	18
Product Features and Benefits .....	18
<b>Wireless Valve Controller (WVC) &amp; Wireless Valve Programmer (WVP)</b>	
Product Comparison .....	24
Technical Information.....	25
Product Explanation.....	25
Product Components.....	25
Installation .....	26
Programming .....	29
Troubleshooting .....	35
<b>Training Manual Quiz .....</b>	<b>35</b>
Quiz Answers.....	36

## APPLICATIONS FOR BATTERY-POWERED CONTROLLERS

### ***Irrigate Sites Where Electrical Power is not Readily Available...***

#### *Reduce overall system installation costs*

Paying an electrical utility company to provide an electrical power source to a remote site can be very costly. In these cases, it is much more prudent to avoid these costly fees by installing a battery-powered irrigation controller rather than a traditional electrically powered irrigation controller. By using the Hunter SVC or WVC battery-powered controller on these systems, clients will be furnished vandal-resistant and reliable system operation at a much lower overall installed cost.

### ***Irrigate Remote Landscapes...***

#### *When valve wire runs are not possible*

If you have chosen not to irrigate an area because of the inability or extreme difficulty of getting valve control wires from the irrigation controller to each individual valve, then the Hunter SVC or WVC battery-powered controller is the perfect choice.



A common application in which contractors have found a battery-powered controller to be an ideal choice is on street median landscapes as it can be extremely difficult and

costly, not to mention dangerous, to run electrical power or valve wires across a busy street.

### ***Retrofit or Repair Existing Systems...***

#### *No wires make it an easy process*

You are faced with an irrigation system that has some challenging troubleshooting issues. Two common scenarios in which a battery-powered controller would be an ideal solution are:

1. An additional valve needs to be added to a system because the zone is hydraulically overloaded due to too many sprinklers installed on the zone.
2. Valve wires have been damaged causing a particular valve not to operate. The

prospect of adding another valve, running additional wire, or identifying and fixing the damaged valve wire is cost-prohibitive.

Using a Hunter SVC or WVC battery-powered controller makes a system retrofit or valve wire repair an easy process.

### ***Temporary Solution for a Site Without Standard Electrical Power...***

#### *When the landscaping must go in right now!*

There are many times when a contractor must go onto a job site and install all the plant material along roadways and entrances before electrical power has



been established for an irrigation controller hookup. Many developers like to have aesthetically pleasing areas in public view to bring customers into a new development. At this point the irrigation contractor has one of two choices:

1. Pay a crewmember to go to the job site frequently to manually open each individual control valve, wait for the zone to be irrigated completely, and then manually shut down each individual control valve.
2. Install a battery-powered controller on the valves for a temporary automatic watering solution.

Obviously, the most cost-effective solution is to install a battery-powered controller to provide temporary automatic irrigation.

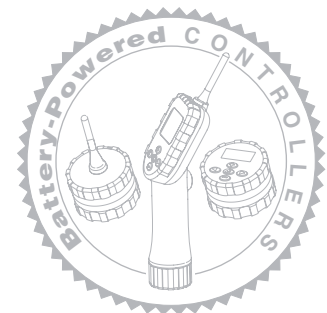

## APPLICATIONS FOR BATTERY-POWERED CONTROLLERS *(continued)*

### *Temporary Operation of AC Powered Irrigation Systems During Power Interruption...*

*Keep the existing landscape irrigated while making electrical repairs*

There are times when a “simple” wiring repair stretches into a few days of work. In the heat of summer those few days may spell doom to the plant material attached to those zones under repair. To solve the problem, install a battery-powered controller on those zones and keep everything watered while the repair is being completed.

## PRODUCT OVERVIEW

### *The Hunter Smart Valve Controller... Providing reliable control without the need of an electric power source*

If an area is not getting irrigated simply because of the high cost associated with getting wires from the controller to the valves, Hunter provides the ideal economical answer that allows automatic operation of your irrigation system without the need for a direct connection to an electrical power source.

The Smart Valve Controller mounts to a valve solenoid quickly and easily — without screws, drills or wires! — and the SVC’s solid construction ensures that it can handle the harsh environment of a valve box. This rugged product is fully submersible and resists all moisture intrusion in water, mud and debris as deep as 12 feet.

But brawn isn’t all this controller has to offer. Operating off a single 9-volt battery that’s guaranteed to provide power to activate the valve through a full season, exceptional reliability is a key feature, as well.

It’s also a breeze to program. With an easy to read and understand LCD display and easy to understand programming buttons, this unit is as easy to program as other Hunter Controllers. Providing up to nine start times, and run times up to 4 hours, the

SVC controller is flexible enough to handle schedules needed for standard irrigation practices as well as the scheduling demands needed for applications such as establishing newly seeded turf or irrigating steep slopes with no runoff.

For isolated sites or power-restricted areas, and for the special needs of drip zones, the new Hunter Smart Valve Controller is your alternate power solution.

## PRODUCT FEATURES AND BENEFITS

### *Single or Multiple Valve Operation Without Power... Simple control for valve operation*

For single station valve operation in the absence of standard electrical power, the Hunter SVC-100 is the answer. The multi-station SVC-400 permits automatic control of up to 4 zone valves. These battery-powered controllers are just one more of the latest in a long history of quality irrigation products our customers have requested.

### *Guaranteed One or More Full Seasons of Operation Without Battery Replacement... 9-volt battery-powered*

Whereas some battery-powered controllers require up to 3 different batteries, the Hunter SVC uses only one 9-volt battery, which will easily power it for at least one full irrigation season. Even if your irrigation schedule requires the Hunter SVC controller to provide power to each valve to irrigate 9 times each day, the battery in the Hunter SVC controller will power the valve for a full season.

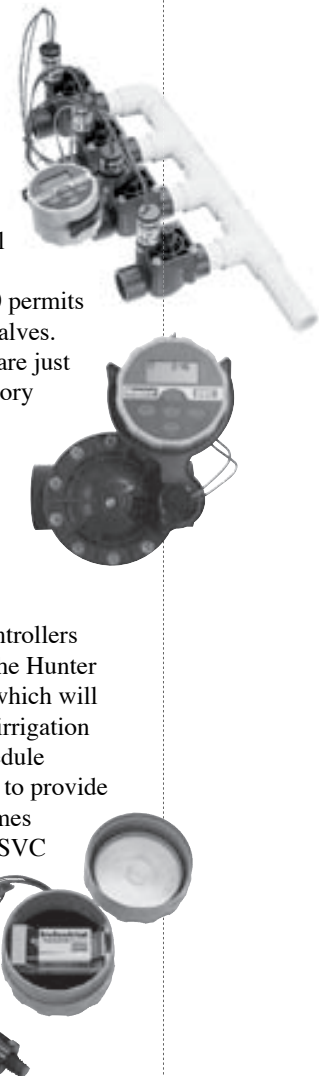

# Smart Valve Controller (SVC)

## ***Latching Solenoid Design for Minimal Battery Power Consumption...***

*No need to check the battery more than once a year.*

Using a unique latching solenoid design on the valve, the Hunter SVC battery-powered controller consumes very little power, which allows the controller to operate valves for a full season.

What is a latching solenoid? Latching solenoids are activated in the same manner as a traditional non-latching solenoid. The controller sends a positive pulse to the DC latching solenoid causing the solenoid plunger to "pull up" which drains the upper chamber of the valve. This causes the diaphragm to lift off the valve seat which allows the valve to open (turn on). This is where the similarities end. In standard non-latching solenoids, in which the traditional controller must provide a constant power supply to the solenoid coil to hold the plunger up, the direct current (DC) latching solenoid plunger is held in place by the magnetic field generated by the magnet around the bottom of the solenoid cavity. When the irrigation program is finished, the battery-powered controller sends a very short negative pulse to the DC latching solenoid, causing the plunger to drop. This allows the upper chamber to fill with water, causing the diaphragm to seal against the valve seat and close the valve. These short pulses consume very little battery power, allowing a battery-powered controller to work for many, many cycles.

The DC latching solenoid is pre-attached to the SVC-100 unit utilizing a black wire lead and a red wire lead. The 24" wire leads allow the user to conveniently program the SVC from outside the valve box. The SVC-400 comes with 12" of wire to allow connection of up to 4 DC latching solenoids (solenoids sold separately).



## ***Non-Volatile Memory...***

*Maintains irrigation programs indefinitely*

The Hunter battery-powered controllers have what many of the sophisticated electronic controllers have: a non-volatile memory. With the controller's non-volatile memory, the set irrigation program is maintained indefinitely, providing a useful feature when the controller battery becomes weak or when the battery needs to be replaced. The replaceable 9-volt alkaline battery keeps the time of day and operates the DC solenoids. The controller program is maintained through the controllers' non-volatile memory.

## ***Controller is Waterproof up to 12 Feet of Submersion...***

*Moisture intrusion is non-existent*

In-ground valve boxes, which can create extremely humid environments, are not a problem for the SVC battery-powered controller. Installers and users can rest assured that moisture intrusion will not occur in the Hunter SVC controller as the sealed case is completely waterproof and provides protection from humidity as well as submersion in water up to twelve feet deep.

## ***Double Sealed Battery Compartment...***

*Double protection against battery damage due to water intrusion*

A concern of contractors about connecting battery-powered controllers in below ground valve boxes is the controller's ability to

withstand water intrusion into the battery compartment. All Hunter battery-powered controllers are designed with a double rubber seal (one O-ring seal in the body and a second seal inside the cap) to guard against water intrusion into the unit.



## PRODUCT FEATURES AND BENEFITS *(continued)*

### **User-Friendly Programming...**

*Same programming flexibility and simplicity as all Hunter irrigation controllers*

By incorporating an electronic push-button interface, the SVC allows complete custom programming for irrigation start times, run times and days of the week. Unlike other battery-powered controllers on the market, users are not forced to settle on factory preset irrigation schedules that may not meet the unique irrigation requirements of your site.



### **Electronic Keypad, with Rubber Buttons...**

*No loose dials or parts to lose*

The Hunter SVC utilizes a hermetically-sealed pushbutton keypad to program the controller, so there are no removable parts to lose in the valve box. By simply pushing the faceplate buttons these units can be programmed to operate valves with the same ease and programming flexibility as the versatile Hunter Pro-C controller.



### **Three Options for Simple Valve or Valve Box Installation...**

*Quick and efficient installation options save time and money*

Three different ways to mount the SVC controller gives the installer options to keep the controller up in the valve box out of the mud. The three options are:

1. Mount to a Hunter Industries valve solenoid using the clip bracket.
2. Mount on the side of the valve box using sheet metal screws and the wall/pipe bracket.
3. Mount on a section of ½" PVC pipe using the wall/pipe bracket. This mounting

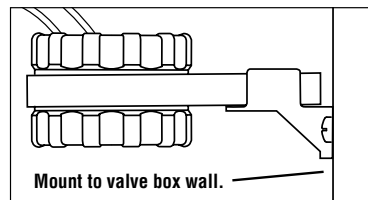

option can be very useful when the other mounting options represent a tight fit in the valve box or when the valve is installed deep in the ground.

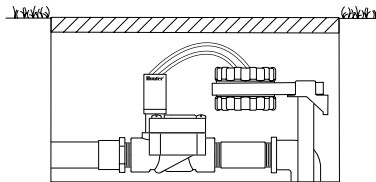

Unit can be mounted on ½" pipe for convenient access.

### **Quick Convenient Combo Kit with a 1" PGV Valve...**

*Retrofitting an additional zone has never been easier*

When addressing the need to add an additional valve to the system during a retrofit or just installing a single valve for a drip zone, the combination SVC controller/PGV Valve kit (model SVC-100-Valve) makes for a quick and hassle-free solution. The kit includes a 1" PGV Valve with Flow Control with a DC latching solenoid and an SVC Controller as well as all mounting brackets.



# Smart Valve Controller (SVC)

## **Universal Controller for Most Standard Irrigation Valves...**

*Operate most irrigation valves found on a job site.*

The SVC controller will operate on all Hunter plastic valves in conjunction with the Hunter DC latching solenoid. The versatile SVC controller will operate on most other manufacturer valves when connected to a compatible DC latching solenoid.

## **LCD with Interactive Icons...**

*Internationally recognized programming icons*

The large LCD display on the controller with its interactive icons simplifies programming by using internationally recognized symbols for programming functions. Also, the display is easy to read and verify, making programming entries easy to understand in any language.



## **Battery Life Status Indicator...**

*Low battery warning*

How much useful battery life is left? For battery-powered controllers produced in the past, the answer has always been, "I don't know." With Hunter's SVC battery-powered controller, you are always aware of the battery's life because of a battery consumption icon in the LCD display. Now you have the option of replacing the battery only when it actually needs replacing and not before, saving both time and money.



## **Rugged and Compact Design...**

*Big things come in small packages*

Built tough, the Hunter battery-powered controllers are designed to last many years in harsh environments. Designed for the realities of the valve box environment, the unit is compact enough to take up very little space in a valve box. A good example of the built-in ruggedness of the controller is found

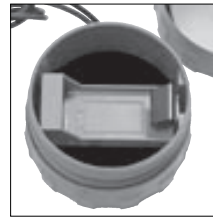

in something as simple as the 9-volt battery connection...not the wire type, which can snap or corrode over time; but a permanently mounted clip, which the battery slides into.

## **Vandal Resistant...**

*Out of sight, out of mind*

Now you can actually install an irrigation controller down in a valve box without causing irreparable harm to the controller. But only when a battery-powered controller such as the Hunter SVC is used. Why put a controller in a valve box? How about keeping the controller completely hidden from view. If controller vandalism is a problem in the area then the best solution is a battery-powered controller.

## **Valve Locations up to 100 Feet Away from the Controller...**

*Remote valves covered from one location*

The capability to operate valves from a location outside of a valve box is a convenient feature asked for by many contractors who install battery-powered controllers. Using a minimum size of #18 gauge UL/UF control wire allows the SVC Controller to be placed up to 100 feet from the valves it controls.

## **Weather Sensor Compatible...**

*Built-in rain sensor circuit can be connected to all Hunter weather sensor products*

A Hunter rain sensor can be connected to any Hunter battery-powered controller. The purpose of a sensor is to stop watering when weather conditions dictate. The hookup is as simple as cutting the yellow colored wire on the SVC unit and attaching the sensor wires to the two ends.

Be sure to use waterproof connectors.

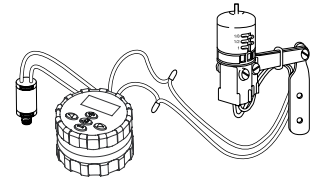

## PRODUCT FEATURES AND BENEFITS *(continued)*

### **Up to Nine Start Times Available...**

*Special watering requirements for new landscapes or slopes is accounted for*

You are in complete control when it comes to programming irrigation starts in the SVC. As with all Hunter controllers, setting the start time is as simple as pushing the up or down arrow buttons to the desired time. With its nine available start times, the SVC offers the flexible watering schedules needed for establishing new turf or irrigating steep slopes that require multiple start times to avoid runoff.

### **One Touch Manual Start...**

*Simple operation for a quick water check of the zone*

A feature that Hunter has incorporated into the SVC controller is called the One Touch Manual Start. It increases the user-friendliness of the controller by using fewer steps to activate zones manually. This feature is great when extra watering is needed but you don't want to spend time putting in a new program. When the time of day and battery indicator are showing in the display, push the right arrow button  until an icon of a hand is shown in the display. Enter the amount of time you would like the zone to run. The zone will activate after a 10 second pause.



### **Choice of Independent Day Scheduling Options...**

*Days of the week or 31-day interval for maximum flexibility*

The choice of Day of the Week or a watering interval up to 31 days apart may be selected. This allows the user to water on certain days of the week such as Monday, Wednesday and Friday or water on a repeating day cycle (interval) such as every 5 days, providing watering flexibility for a drip zone.



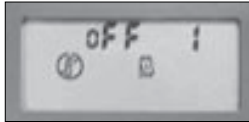

### **Programmable 0-7 Day Rain Delay...**

*No need to return to the controller after it stops raining*



The SVC allows you to turn off the controller for a predetermined period of time

(0-7 days) during rainy weather. After the specified period has elapsed, the controller will return to automatic mode and water as scheduled. This delay feature is very convenient in residential or commercial systems because when the operator uses this delay feature; there's no need to worry about remembering to go back and turn it on. This delay is accessed by pushing the enter button  until the sprinkler off symbol is showing then push the  button to the number of days of delay.

### **Up to Four Hours Run Time...**

*Allows watering for all types of plant material, from groundcover to trees*

Up to four hours of run time can be programmed in one-minute increments. The factory default is set at 0 minutes to keep the valve from operating before programming. The battery-powered controller will keep the run time within its memory after programming, even during battery replacement using its non-volatile memory.

### **Multi-language Capability...**

*Instructions in four languages*

These battery-powered controllers have integrated international requirements into their design. Each unit uses internationally recognized icons for each programming sequence. A label is affixed on the back of the unit in four different languages; English, Spanish, French and Italian.



# Smart Valve Controller (SVC)

## **AM/PM or 24-Hour Clock Settings...**

*Choose your favorite method of designating time*

The SVC allows the user to select the option of operating the controller in an AM/PM mode or 24-hour mode.

In most markets around the world, the 24-hour mode

is the most common means of designating time, while in the U.S. market customers most often utilize an AM/PM mode. The SVC was designed to meet the needs and provide for convenient ease of programming for all Hunter customers worldwide.



## **Automated Chronological Ordering of Start Times...**

*No more "phantom" starts!*

When more than one start time is entered into the SVC, in any order of time sequence, the battery-powered controller will automatically shift the start times into ascending order from the earliest start time to the latest start time.

The SVC will also shift or move start times up the cue if times were inadvertently added after empty start time slots (up to 9 slots). For example, after programming is complete the controller will automatically fill the Start #1 slot first, and then the #2 slot second and so on, making it easier for the user to recheck the times. No "phantom" starts will occur from a start time buried deep in the program.

The SVC-400 is capable of operating up to 4 valves at the same time. Setting the same start times for each zone allows for simultaneous valve operation.

## **2-Year Warranty...**

*Hunter Industries backs up the products*

A full two-year warranty by Hunter communicates to our customers that the SVC battery-powered controller stands up to the harsh environment of being placed in a valve box. Like all other Hunter Products, you can be assured of a quality product with a guarantee of dependable operation.

## PRODUCT COMPARISON

### Battery-Powered Controllers

Features	HUNTER® SVC	NELSON® SOLORAIN™ 8010	NELSON® SOLORAIN™ 8014	RAIN BIRD® EASY RAIN™	DIG® 510.000	DIG® 540.000
Number of Stations	up to 4	1	1	1	1	up to 4
100% Digital Programming	✓				✓	✓
Push Button or dial Programming	push button	3 dials	2 dials	1 dial	push button	push button
Three Controller Mounting Options, including Solenoid, Valve Box Wall, or PVC Tube	✓	solenoid only	solenoid only	solenoid only	solenoid only	solenoid/valve box
Type of Battery	9V alkaline	9V alkaline	lithium	9V alkaline	(2) 9V alkaline	(2) 9V alkaline
100 Year Non-Volatile Program Memory	✓					
LCD Displays Clock and International Programming Icons	✓				✓	✓
Battery Life Status Indicator	✓				✓	✓
Max. Distance Valve Can be Located from Controller Using #14 UL Wire	100'	n/a	n/a	n/a	10'	
Programmable Clock for Current Time	✓		✓		✓	
Standard Weather Sensor (switch type) Compatible	✓		special model only		special model only	
Multi-language Instructions on Unit	✓					✓
Manual On/Off	✓	✓	✓	✓	✓	✓
Manual Start	✓	✓	✓	✓	✓	✓
Days-of-the-Week Programming	✓		✓		✓	✓
Interval Programming	31 days	3 days	30 days	3 days	30 days	30 days
Programmable Rain Delay	✓		✓		✓	✓
AM/PM or 24 Hour Clock Settings	✓					
Waterproof Depth	12'	6'	6'	6'	6'	6'
Max. Station Run Time per Start	4 hrs	5.5 hrs	12 hrs	1.5 hrs	12 hrs	12 hrs
Valve Starts per Day	9	6	6	1 or 2	4	4
<small>Rain Bird® is a registered trademark of Rain Bird Sprinkler Manufacturing Corporation  Nelson® is a registered trademark of L. R. Nelson Corporation  Dig® is a registered trademark of Dig Corporation</small>						

# Smart Valve Controller (SVC)

## PRODUCT COMPONENTS

### Control Buttons

- ➔ **Button** – Increases the selected flashing display.
- ➞ **Button** – Decreases the selected flashing display.
- **Button** – Selects programming function.
- **Button** – Advances the selected flashing display to the next item.
- **Button** – Navigates the selected flashing display back to the previous item.

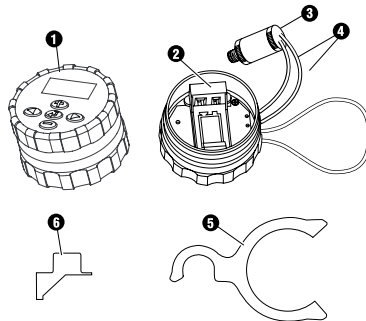
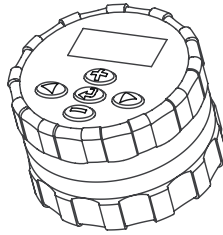

1. **SVC Body** – The SVC controller is designed to be dirt tolerant, waterproof, and submersible to 12 feet.
2. **9-Volt Battery Holder** – The SVC is designed to operate on a single 9-volt alkaline battery. The battery easily snaps into the battery holder.
3. **DC Latching Solenoid** – Hunter DC Latching Solenoid is provided on SVC-100 only.
4. **Weather Sensor Wires** – A Hunter Mini-Clik® or Rain-Clik™ can be connected to the SVC.
5. **Valve Mounting Clip** – Allows the SVC to be mounted directly on any Hunter valve. The clip can also be used in conjunction with the Universal Mounting Adapter.
6. **Universal Mounting Adapter** – Allows for alternate methods of mounting the SVC. It can be used to mount the SVC to the side of the valve box or mounted on a ½" (13 mm) diameter section of plastic pipe.

## INSTALLATION INSTRUCTIONS

### Connecting the Battery

The SVC uses a standard 9-volt alkaline battery (not included) to operate the valve and program the controller. The life of the battery is determined by the number of valve actuations, however, under normal conditions the battery should provide at least one full year of service.



NOTE: The SVC has non-volatile memory which allows for the battery to be removed without losing any program information.

### To install the battery:

1. Unscrew the rear half of the SVC body to gain access to the battery compartment.
2. Snap the battery into the battery holder.

NOTE: The battery holder is designed so that the battery can only be inserted one way.

3. Make sure no water is inside the battery compartment. Screw the SVC body halves together to seal the compartment.



### Attaching DC Latching Solenoids to the SVC-400

The SVC-400 is capable of operating up to four individual DC latching solenoids. Hunter DC solenoids (P/N 458200) can easily be installed on all Hunter Plastic Valves. (Solenoids ordered separately for the SVC-400.)



NOTE: Must use DC Latching Solenoids. 24VAC Solenoids will not operate with the SVC.

Common Wire (Black Leads)

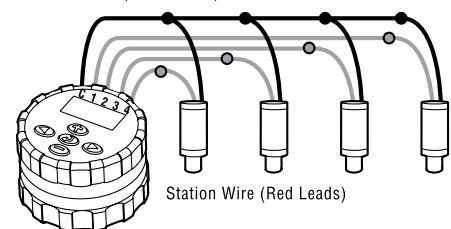

## INSTALLATION INSTRUCTIONS (Continued)

### To Wire DC Solenoids to the SVC-400:

1. Attach the black leads from each solenoid to the single common wire (black lead) coming from the SVC. Secure all wire connections with waterproof connectors.
2. Attach one red wire from each solenoid to the corresponding station wire (red lead) from the SVC. The station numbers are identified on the face of the SVC. Secure all wire connections with waterproof connectors.



NOTE: The maximum wire distance between the solenoid and SVC is 100 feet (18 gauge minimum wire size).

The SVC can also operate non-Hunter DC latching solenoids. Below is a list of SVC compatible solenoids.

Model	Solenoid
Baccara	G75-0-1002
Bermad	S392-2
Nelson	8090
Rain Bird	TBOSPSOL

### Mounting to a Hunter Valve

The SVC can easily be mounted on any Hunter plastic valve. A specially designed valve mounting clip makes installation a snap.

A protective rubber cover is provided to prevent dirt from accumulating on the face of the SVC.

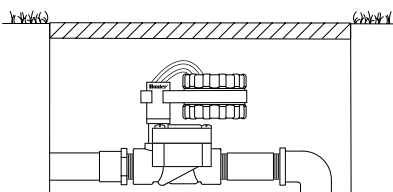

### To Mount the SVC to a Hunter Valve (Figure 1):

1. Unscrew the existing solenoid from the valve.
2. Screw the SVC latching solenoid into the valve bonnet.
3. Attach the large end of the valve mounting clip to the middle of the SVC body.
4. Snap the small end of the valve mounting clip to the solenoid.

### Alternate Mounting Methods

A universal mounting clip and mounting adapter are also provided with the SVC. These allow for alternate methods of mounting the controller either to the side of the valve box or stake mounted within the valve box.

### Valve box mounting method (Figure 2)

1. Position the universal mounting adapter on the side of the valve box. Make sure that the bracket is positioned so the controller will not interfere with the top of the valve box cover.
2. Drive two screws to secure the adapter to the side of the valve box.
3. Attach the SVC to the mounting clip and slide it on the end of the mounting adapter.

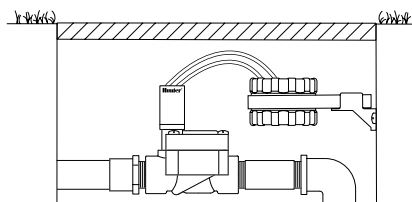

# Smart Valve Controller (SVC)

## Stake Mounting Method (Figure 3)

The universal mounting adapter can also be used to stake mount the SVC.

1. Cut a section of ½" (13 mm) diameter plastic pipe.
2. Drive the pipe into the ground inside the valve box to the desired height of the controller.
3. Slip the mounting adapter on top of the pipe.
4. Attach the SVC to the mounting clip and slide onto the adapter.

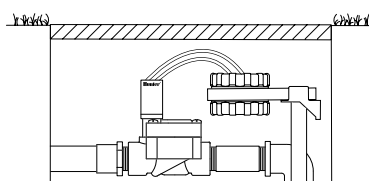





Figure 3

## Connecting a Weather Sensor



A Hunter Rain-Clik™ rain sensor or Mini-Clik® rain sensor can be connected to the SVC. The purpose of this sensor is to stop watering when weather conditions dictate.

 NOTE: When the Rain Sensor is interrupting the watering, the display will show the System Off icon , "OFF" and  on the display.

## To connect a weather sensor to the SVC:

1. Cut the yellow wire loop attached to the SVC at approximately the middle of the loop.
2. Remove approximately ½" (13 mm) of insulation from each wire. Attach each wire to each of the wires of the weather sensor. You can mount the rain sensor up to 100' from the SVC (18 gauge minimum wire size).
3. Secure wire connections with waterproof connectors.

## Battery Life Indicator



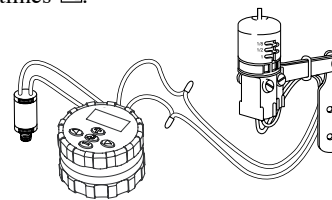



The battery life status icon  is a quick way to determine the remaining life of the installed battery without having to remove the battery from the controller. A battery life status icon will appear along with the time and day on the display. A fully charged battery will show all three segments of the battery dark . As the battery is expended, the segments will appear as outlines .



## PROGRAMMING THE SVC-100















### *Programming the Controller*

The SVC is easy to program. The easy-to-understand icons and push button design allows you to step through the process of programming and activate manual watering with the press of a button.

The SVC display shows time and day when the  button is pressed. The  button allows you to navigate among programming options. During a short period of inactivity, the display will shut off to retain battery power. When programming, the flashing portion of the display can be changed by pressing the  or  buttons. To change something that is not flashing, press the  or  buttons until the desired field is flashing.



The SVC allows for up to 9 start times. Multiple start times permit morning, afternoon and evening watering, perfect for the establishment of new lawns and thirsty annual flowers. Simply designate the days of the week you want to water. The SVC makes it easy.



### *Setting the Date and Time*

1. Press the  button until the Current Time/Day icon  is displayed.
2. Hours will be flashing. Press the  or  button to change the hour shown on the display. Press the  to proceed to setting the minutes.
3. Minutes will be flashing. Use the  or  button to change the minutes shown on the display. Press the  to proceed to select AM, PM or 24 hour time.
4. The time will be displayed, and the time of day flashing. Press the  or  button to select AM, PM or 24 hour. Press the  to proceed to setting the day of the week.
5. The  icon will appear and the day of the week will be flashing. Press the  or  buttons to select the day of the week (1 through 7) corresponding to the day.



The time and day have now been set.

### *Setting Watering Start Times*

1. Push the  button until the Start Times icon  is displayed.

2. Use the  or  button to change the start time. (The start times advance in 15 minute increments.) Hold either button down for 1 second to change times rapidly.
3. Press the  button to select the next start time (up to 9 start times are available).





### *Eliminating a Start Time*

With the display in the watering Start Time mode, push the  or  button until you reach 12:00 AM (midnight). From here push the  button once to reach the OFF position.









NOTE: If the SVC has all 9 start times turned off, then the controller is off.





### *Setting the Run Time (Length of Watering)*

1. Press the  button until the Run Time icon  is displayed.
2. The display will show the last run time entered.
3. Use the  or  button to change the station run time on the display from 1 minute to 4 hours.

### *Setting Days to Water*

1. Push the  button until the Water Days icon  is displayed.
2. The controller will display seven days of the week with a  icon or a  icon above the numbered day. The  icon would represent an "On" water day, while the  icon would represent an "Off" watering day.

### *Selecting Specific Days of the Week to Water*

1. With the  cursor on a specific day (the cursor always starts with 1), press the  button to activate a particular day of the week to water. Press the  button to cancel watering for that day. After pressing a button the cursor automatically advances to the next day.
2. Repeat step 1 until all desired days have been selected. The selected days will show with a  to indicate their status ON. The last  is the last watering day for the program.

# Smart Valve Controller (SVC)

## **Selecting Interval Watering**

With this option you can select interval watering from 1 to 31 days.

1. With the ▲ cursor on day 7, press the ► button until the ☞☞ interval watering icon and the two calendars appear on the display.
2. Press the ⊕ or ⊖ button to select the number of days between watering days (1 to 31). This is called the interval.

The controller will water the next Start Time and will then water at the interval programmed.

## **System Off**

This function permits the user to shut the system off for an indefinite period of time.

1. Press the mode button ⏻ until the ☞ Crossed Sprinkler icon is displayed.
2. Wait 4 seconds and “Off” will appear on the display. The SVC is now in the System Off mode and will remain off until it is turned back on again.

## **To activate the controller from the System Off mode:**

1. Press the mode button ⏻ once. The display will wake up in the System Off mode.
2. Press the mode button ⏻ again and “Off” will disappear from the display. Your controller is now on and will water automatically based upon the current program.

## **Programmable Rain Off**

This feature permits the user to stop all programmed waterings for a designated period from 1 to 7 days. At the end of the programmable rain off period, the controller will resume normal automatic operation.

1. Press the ⏻ button until the ☞ System Off icon is displayed. Wait 4 seconds and “OFF” will appear on the display.
2. Press the ⊕ button and a 1 will be displayed. The 1 will be blinking at this point.

3. Press the ⊕ button as many times as needed to set the number of days off desired (up to 7).

## **Manual Watering**

To activate a Manual Watering:

1. Press the ⏻ button once to display the ☞ Current Time/Day icon.
2. Press and hold the ► button for two seconds to display the ☞ Manual Watering icon.
3. Use the ⊕ or ⊖ button to adjust the manual water run time from 1 minute to 4 hours.
4. Release the buttons and the controller will count down 10 seconds before activating the manual cycle.
5. The ☞ flashing sprinkler icon will appear on the display when watering is occurring.

## **To suspend Manual Watering:**





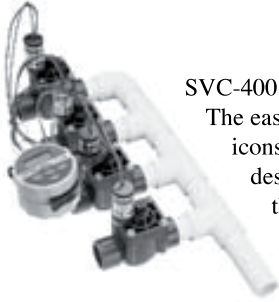

1. Press the ⏻ button until the ☞ System Off icon is displayed. Wait 4 seconds and “OFF” will appear on the display.
2. Press the ⏻ button again and the SVC will water based upon the current program.

## PROGRAMMING THE SVC-400













SVC-400 is easy to program. The easy-to-understand icons and push button design allows you to step through the process of programming and activate manual watering with the press of a button.



The SVC-400 utilizes independent station programming. For each station being programmed, you need to program at least one Start Time, a Run Time and Water Day(s). The  button allows you to quickly navigate among programming options.

The SVC display shows time and day when the  button is pressed. The  button allows you to easily navigate among programming options. During a short period of inactivity, the display will shut off to retain battery power. When programming, the flashing portion of the display can be changed by pressing the  or  buttons. To change something that is not flashing, press the  or  buttons until the desired item is flashing.

The SVC allows for up to 9 start times per day. Multiple start times permit morning, afternoon and evening watering, perfect for the establishment of new lawns and thirsty annual flowers. Simply designate the days of the week you want to water. The SVC makes it easy.













### Setting the Date and Time

1. Press the  button until the Current Time/Day icon  is displayed.
2. Hours will be flashing. Press the  or  button to change the hour shown on the display. Press the  to proceed to setting the minutes.
3. Minutes will be flashing. Use the  or  button to change the minutes shown on the display. Press the  to proceed to select AM, PM or 24 hour time.
4. The time will be displayed, and the time of day flashing. Press the  or  button to select AM, PM or 24 hour. Press the  to proceed to setting the day of the week.



5. The number 1 will be flashing at the bottom of the display, indicating the first day of the week. Press the  or  buttons to select the day of the week (1 through 7) corresponding to the day.

The time and day have now been set.

### Setting Watering Start Times

1. Push the  button until the Start Times icon  is displayed. A Start Time or "Off" will be flashing. The number directly to the left of the start time number (1 through 9) indicates the start time number. The number directly below the start time number indicates the station being programmed.
2. Use the  or  button to change the start time. (The start times advance in 15 minute increments.) Hold either button down for 1 second to change times rapidly.
3. To add another start time to the station, press the  button. The start time icon and start time number will be flashing. Use the  or  buttons to change the start time number.
4. Press the  button. The start time will be flashing. Use the  or  buttons to change the start time.
5. To program start times for another station, press the  button. The station number will be flashing. Use the  or  buttons to select the next station (1 through 4). Repeat steps 3 and 4.

### Eliminating a Start Time





With the display in the watering Start Time mode, push the  or  buttons until you reach 12:00 am (midnight). From here push the  button once to reach the OFF position.









NOTE: If a station has all 9 start times turned off, then the station is off.

# Smart Valve Controller (SVC)





## **Setting the Run Time (Length of Watering)**

1. Press the  button until the Run Time icon  is displayed.
2. The display will show the last run time entered.
3. Use the  or  button to change the station run time on the display from 1 minute to 4 hours.
4. Press the  button to navigate to the next station number to be programmed.

## **Setting Days to Water**



1. Push the  button until the Water Days icon  is displayed. The station number will also be displayed.
2. The controller will display seven days of the week with a  icon or a  icon above the numbered day. The  icon would represent an “On” water day, while the  icon would represent an “Off” watering day.
3. Use the  button to navigate to the next station to be programmed.



## **Selecting Specific Days of the Week to Water**

1. With the  cursor on a specific day (the cursor always starts with day 1), press the  button to activate that day of the week to water. Press the  button to cancel watering for that day. After pressing a button the cursor automatically advances to the next day.
2. Repeat step 1 until all desired days have been selected. The selected days will show with a  to indicate their status ON. The last  is the last watering day for the program.

## **Selecting Interval Watering**

With this option you can select interval watering from 1 to 31 days.

1. With the  cursor on day 7, press the  button until the  interval watering icon and the two calendars appear on the display.

2. Press the  or  button to select the number of days between watering days (1 to 31). This is called the interval.

The controller will water the next Start Time and will then water at the interval programmed.



## **Programming Stations to Operate Together**

The SVC-400 allows for automatic watering of multiple valves at the same time. Up to four stations can operate at the same time. If more than one station has the same start time, they will operate together (they must also be programmed with the same water day). For example, if Station 1 and 2 both have been programmed with start times of 8:00 am, they will both turn on and run at the same time.

The SVC allows for start time stacking which is helpful when system capacity is not adequate to support the operation of multiple valves at the same time. Let's assume a scenario in which Station 1 is programmed to start at 8:00 am and run for 15 minutes, and Station 2 is programmed to start at 8:10 am and run for 15 minutes. Station 1 watering run time overlaps Station 2 start time. The SVC will wait until Station 1 completes watering until it starts Station 2. In this scenario, Station 2 will start at 8:15 am.



## **System Off**

This function permits the user to shut the system off for an indefinite period of time.

1. Press the mode button  until the  Crossed Sprinkler icon is displayed.
2. Wait 4 seconds and “Off” will appear on the display. The SVC is now in the System Off mode and will remain off until it is turned back on again.





## PROGRAMMING THE SVC-400 (continued)

### To Activate the Controller from the System Off Mode

1. Press the mode button  once. The display will wake up in the System Off mode.
2. Press the mode button  again and "Off" will disappear from the display. The display will show the current time. Your controller is now on and will water automatically based upon the current program.

### Programmable Rain Off





This feature permits the user to stop all programmed waterings for a designated period from 1 to 7 days. At the end of the programmable rain off period, the controller will resume normal automatic operation.



1. Press the  button until the  System Off icon is displayed. Wait 4 seconds and "Off" will appear on the display.
2. Press the  button and a 1 will be displayed. The 1 will be blinking at this point.
3. Press the  button as many times as needed to set the number of days off desired (up to 7). The SVC will wait the number of days selected and then reactivate automatic watering.

### Manual Watering

The SVC-400 features a simple one touch manual start. One or more stations can be programmed to run manually at the same time.

#### To Activate a Manual Watering:



1. Press the  button once to display the current time of day.
2. Press and hold the  button for two seconds to display the  Manual Watering icon. The station number will also be displayed.
3. Use the  or  button to adjust the manual water run time from 1 minute to 4 hours.
4. Release the buttons and the controller will count down 10 seconds before activating the manual cycle.

5. The  flashing sprinkler icon will appear on the display when watering is occurring.
6. To activate another station, use the  button to select the station you would like to manually water, repeat steps 3 and 4.







Note: While manual watering is occurring the display will briefly display the station number and the remaining watering time for each station that is operating. The manual water run time can be increased or decreased for any time that the station is displayed.

#### To Suspend Manual Watering to All Stations Operating:

1. Press the  button until the  System Off icon is displayed. Wait 4 seconds and "OFF" will appear on the display. All stations will turn off.
2. Press the  button again and the current time and day will be displayed. The SVC will now water based upon the current program.

#### To Suspend Manual Watering to Individual Stations Operating:

1. Press the  button and the display will show each of the stations operating manually.
2. When the station number appears for the station that you would like to suspend manual watering, press the  button once. The time remaining displayed will change to "Off" and the station will turn off.
3. Repeat steps 1 and 2 to suspend watering for additional stations.

The battery life status icon  is a quick way to determine the remaining life of the installed battery without having to remove the battery from the controller. A battery life status icon will appear along with the time and day on the display. A fully charged battery will show all three segment of the battery dark . As the battery is expended, the segments will appear as outlines .

# Smart Valve Controller (SVC)

## TROUBLESHOOTING

PROBLEM	CAUSES	SOLUTIONS
There is no display.	<ol style="list-style-type: none"> <li>1. Display is off.</li> <li>2. Battery is dead.</li> </ol>	<ol style="list-style-type: none"> <li>1. Press any button for 1 second.</li> <li>2. Replace the battery.</li> </ol>
Display indicates watering, but none is occurring.	<ol style="list-style-type: none"> <li>1. No water pressure.</li> <li>2. Faulty solenoid.</li> <li>3. Faulty wire connections, if used.</li> </ol>	<ol style="list-style-type: none"> <li>1. Turn on main system supply.</li> <li>2. Replace solenoid.</li> <li>3. Check and replace wire connections.</li> </ol>
Automatic irrigation does not start at start time.	<ol style="list-style-type: none"> <li>1. Controller in System Off mode.</li> <li>2. AM/PM of time of day not set correctly.</li> <li>3. AM/PM of start time not set correctly.</li> <li>4. Rain sensor is active.</li> <li>5. Faulty rain sensor wire connections.</li> </ol>	<ol style="list-style-type: none"> <li>1. Verify that controller is on.</li> <li>2. Correct AM/PM of time of day.</li> <li>3. Correct AM/PM of start time.</li> <li>4. Wait until the rain sensor is inactive or remove from system.</li> <li>5. Check and replace wire connections.</li> </ol>
Rain sensor does not suspend watering.	<ol style="list-style-type: none"> <li>1. Rain sensor problem.</li> </ol>	<ol style="list-style-type: none"> <li>1. Verify proper operation of the rain sensor and wire connections.</li> </ol>
Controller waters more than one time.	<ol style="list-style-type: none"> <li>1. Too many start times have been entered.</li> </ol>	<ol style="list-style-type: none"> <li>1. One start time activates a complete cycle (see Setting Start Times).</li> </ol>

## TECHNICAL INFORMATION

DIMENSIONS
3.25" diameter x 2" high
OPERATING SPECIFICATIONS
<ul style="list-style-type: none"> <li>• Station run time: 0 to 240 minutes in 1-minute increments</li> <li>• Start times: 9 per day</li> <li>• Day of the week calendar</li> <li>• AM/PM or 24-hour clock option</li> <li>• Start time stacking</li> <li>• Easy to understand icon-based display</li> <li>• Simplified manual operation</li> <li>• Programmable rain delay for 1 to 7 days</li> <li>• Operates valves up to 100' away from controller</li> </ul>
ELECTRICAL SPECIFICATIONS
<ul style="list-style-type: none"> <li>• Power: 9V alkaline battery</li> <li>• Battery life: minimum one year with top quality alkaline battery</li> <li>• Memory: Non-volatile for program data</li> </ul>
ADDITIONAL FEATURES
<ul style="list-style-type: none"> <li>• Prewired cable included (for programming outside the valve box, if desired)</li> <li>• Clip bracket for simple installation</li> <li>• Rubber cover prevents dirt and debris from accumulating on face of controller</li> </ul>

## PRODUCT EXPLANATION

SPECIFICATION GUIDE	
EXAMPLE: <b>SVC - 100</b>	
MODEL	FEATURES
SVC	<ul style="list-style-type: none"> <li>100 = Single-Station Controller (Solenoid Included)</li> <li>100-VALVE = Single-Station Controller with PGV-101G Valve</li> <li>100-VALVE-B = Single-Station Controller with PGV-101G-B Valve (BSP Threads)</li> <li>400 = 4-Station Controller (solenoids ordered separately)</li> </ul>

DC Latching Solenoid (P/N 458200)

## PRODUCT OVERVIEW

While a multi-station battery-powered controller is not a new type of product, battery-powered controllers that can be counted upon for their consistent performance and reliability most certainly are. With the introduction of Hunter's wireless controller that operates in the absence of a traditional electric power source, anyone who maintains a landscape can quickly and effortlessly install a ruggedly-built, easy-to-understand controller product that will provide reliable performance with a battery life that's guaranteed.

The Wireless Valve System: A rugged, reliable multi-station, multi-function battery-powered controller and programmer. Hunter's new Wireless Valve System makes it possible for a site that lacks standard electric power to enjoy all the benefits of automatic irrigation. At traffic medians and roundabouts, rural properties, construction sites and municipal parks, most battery-powered controllers leave you guessing as to when the battery is going to run out. No problem here – battery life is assured through a full season, making replacement a simple annual task.

What else sets this unit apart? There's no need to reach inside the valve box in order to hook up a field transmitter and download program instructions; the programmer can communicate with the controller from as far as 100 feet away. Couple this with the wide range of user-friendly operating features and you'll find there's no battery-powered controller on the market that's easier to program.

The Wireless Valve System's control unit is fully submersible and waterproof up to 12 feet, making it rugged enough to withstand whatever water, mud and debris might be found in a valve box environment. And, with all installed components hidden away safely underground and out of view, only the Wireless Valve System can claim to be truly vandal-resistant.

The Wireless Valve System, also consists of a portable wireless programmer that is utilized to schedule an irrigation program in a combination of two or four station wireless controller units from up to 100 feet away.

## PRODUCT FEATURES AND BENEFITS

### *Wireless, Radio Controlled Operation...*

*Keep a lid on it*

It's hot and it's humid or it's cold and raining! It doesn't matter as long as you are using Hunter's new battery-powered Wireless Valve System including the Wireless Valve Programmer (WVP) and Wireless Valve Controller (WVC.) With wireless controller operation you can sit in the comfort of your vehicle with the air conditioning or heater on and take care of business. Play it safe, use Hunter's new wireless battery-powered control system and stay out of heavy traffic when landscaped median controllers need reprogramming. Hunter's new wireless communication for battery-powered controllers eliminates the need to open the valve box to reprogram.

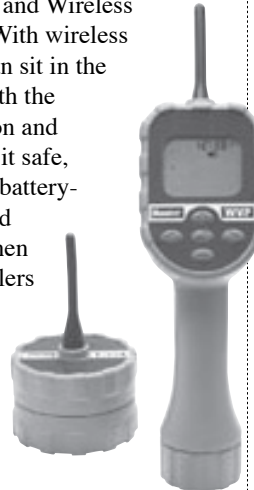

### *WVC-200 & WVC-400 Station Models...*

*For commercial use and residential systems*

The backbone of the Wireless Valve System is made up of rugged and reliable multi-station, multi-function wireless valve controllers. The model WVC-200 is for a two-zone system and the WVC-400 is designed for up to four zones. These sizes meet the requirements of most common battery-powered applications such as street medians, roundabouts and parks.



# Wireless Valve System

## ***Guaranteed One or More Full Seasons of Operation Without Battery Replacement...***

*9-volt battery powered*

Whereas some battery-powered controllers require up to 3 different batteries, the Hunter WVC uses only one 9-volt battery which will easily power it for at least one full irrigation season. Even if your irrigation schedule requires the Hunter WVC controller to provide power to each valve to irrigate 9 times each day, the battery in the Hunter WVC controller will power the valve for a full season.

## ***Latching Solenoid Design for Minimal Battery Power Consumption...***

*No need to check the battery more than once a year*

Using a latching solenoid design, the Hunter battery controllers consume very little power, allowing the controller to operate valves for more than 12 months.



What is a latching solenoid? Latching solenoids are activated in the same manner as a traditional non-latching solenoid. The controller sends a positive pulse to the DC latching solenoid, causing the solenoid plunger to “pull up” which drains the upper chamber of the valve. This causes the diaphragm to lift off the valve seat, which allows the valve to open (turn on). This is where the similarities end. In standard non-latching solenoids, in which the traditional controller must provide a constant power supply to the solenoid coil to hold the plunger up, the direct current (DC) latching solenoid plunger is held in place by the magnetic field generated by the magnet around the bottom of the solenoid cavity. When the irrigation program is finished, the battery-powered controller sends a very short negative pulse to the DC latching solenoid, causing the plunger to drop. This allows the upper chamber to fill with water, causing the diaphragm to seal against the seat and close the valve. Short

pulses consume very little battery power, allowing a battery-powered controller to work for many, many cycles.

The Hunter latching solenoid is packaged as a separate part number, which is p/n 458200. For easy identification, its black and red wires distinguish the Hunter latching solenoid from Hunter’s standard solenoid, which has two red wire leads.

## ***Non-Volatile Memory...***

*Maintains irrigation programs indefinitely*

The Hunter battery-powered controllers have what many of the sophisticated electronic controllers have – a non-volatile memory. With the controller’s non-volatile memory, the set irrigation program is maintained indefinitely, providing a useful feature when the controller battery becomes weak or when the battery needs to be replaced. The replaceable 9-volt alkaline battery keeps the time of day and operates the DC latching solenoids. The controller program is maintained through the controllers’ non-volatile memory.

## ***Controller is Waterproof up to 12 Feet of Submersion...***

*Moisture intrusion is non-existent*

In-ground valve boxes, which can create extremely humid environments for all enclosed components, are not a problem for the WVC battery-powered controller. Installers and users can rest assured that moisture intrusion will not occur in the Hunter WVC controller as the sealed case is completely waterproof and provides protection from humidity as well as submersion in water up to twelve feet deep.



## PRODUCT FEATURES AND BENEFITS *(continued)*

### ***Double Sealed Battery Compartment...***

*Double protection protects against battery damage due to water intrusion*

A big concern of contractors and installers when it comes to hooking up battery-powered controllers in below ground valve boxes is the controller's ability to withstand water intrusion into the battery compartment. All Hunter battery-powered controllers are designed with a double rubber seal (one O-ring seal in the body threads and a second seal inside the cap) to guard against water intrusion into the battery compartment of the unit.

### ***Three Options for Simple Valve or Valve Box Installation...***

*Quick and efficient installation options saves time and money*

Three different ways to mount the WVC controller give the installer options to keep the controller up in the valve box out of the mud. Unique, specially designed controller clip and wall/pipe brackets provide multiple mounting options for the controller. The three options are:

1. Mount to a Hunter Industries valve solenoid using the clip bracket.
2. Mount on the side of the valve box using sheet metal screws and the wall/pipe bracket.
3. Mount on a piece of ½" PVC pipe using the wall/pipe bracket. This mounting option can be very useful when the other mounting options represent a tight fit in the valve box or when the valves are installed deep in the ground.

### ***Universal Controller for Most Irrigation Valves...***

*Operate most irrigation valves found on a job site*

The WVC wireless controller family will operate all Hunter plastic valves in conjunction with the Hunter DC latching solenoid. Also, the versatile WVC controller operates most other manufacturers irrigation valves with the use of a compatible DC latching solenoid on the valve, making it a very universal controller.

### ***Rugged and Compact Design...***

*Big things come in small packages*

Built tough, the Hunter battery-powered controllers are designed to last many years in harsh environments. Designed for the realities of the valve box environment, the unit is compact enough to take up very little space in a valve box.

A good example of the built-in ruggedness of the controller is found



in something as simple as the 9-volt battery connection...not the wire type, which can snap or corrode over time, but a permanently mounted clip which the battery slides into.

### ***No Interface Modules Required...***

*Less parts equals less problems*

When using the Hunter Wireless Valve System, no other piece of equipment such as a radio interface or adapter is required. You only need the wireless WVP handheld programmer and either the 2 station WVC-200 or the 4 station WVC-400 to set up the system. Without the need for an interface module hookup, there is no chance of failure of important connecting devices such as an optical connector or phone jack between the controller and module.

### ***Vandal Resistant...***

*Out of sight, out of mind*

Now you can actually install an irrigation controller down in a valve box without causing harm to the controller, but only when a battery-powered controller such as the Hunter WVC is used. Why put a controller in a valve box?



How about keeping the controller completely hidden from view. If vandalism is a problem in the area, then the solution is a battery-powered controller.

# Wireless Valve System

## **Valve Locations Up to 100' Away From the Controller...**

*Remote valves covered from one location*

The capability to operate valves away from the controller location is often requested. Using a minimum size of #14 gauge UL/UF control wires connecting the WVC Controller to the valve will allow the WVC Controller to be placed up to 100 feet from the valve location.

## **Weather Sensor Compatible...**

*Built-in rain sensor circuit can be connected to all Hunter weather sensor products*

A Hunter Rain-Clik™ rain sensor or any other weather sensor can be connected to any Hunter battery-powered controller. The purpose of a sensor is to stop watering when weather conditions dictate. The hookup is as simple as cutting the yellow colored wire and attaching the sensor

wires to the two ends. Be sure to use 100% waterproof connectors.

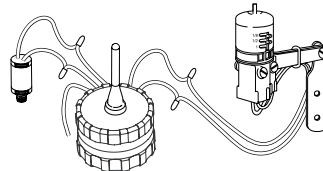

## **FCC Part 15 Compliant...**

*Signal is the maximum within legal limits*

The new Wireless Valve System has passed all the FCC rules and regulations for radio controlled irrigation systems. The bi-directional signal is secure and does not bleed into other frequencies as can happen with radio controlled devices. Crew members will not have to worry about opening somebody's garage door down the street with the transmitter. Because the signal strength is at the maximum set by law, the system easily operates up to 100' in distance.

## **2-Year Warranty...**

*Hunter Industries backs up the products*

A full two-year warranty by Hunter communicates to our customers that the WVC wireless battery-powered system stands up to the environment. The end-user can be assured of a quality product with a guarantee of dependable operation.

## **Remotely Program WVC Controllers Using Hand-Held WVP Programmer up to 100' Away...**

*Wireless communication from across the street*

Make it wireless and make it as user-friendly as possible. That's the directive Hunter was given by the contractors who understand the advantages of battery-powered controls. With its 100' range, the WVP Programmer can program the WVC Controller from "across the street" even when it is down inside a valve box. No longer will crew members have to worry about crossing through busy street traffic to open a valve box just to check or reprogram a battery-powered controller.



## **User-Friendly Programming...**

*Same programmable style as all Hunter Irrigation controllers...*

The WVP programmer transmitter programs in the same user-friendly manner as other Hunter controllers, such as the ICC, Pro-C or EC. By incorporating an electronic interface, the Programmer allows complete custom programming for irrigation start times, run times and days of the week.

## **Ergonomically Designed for Programming Comfort...**

*Takes controller programming to another level*

The WVP is ergonomically designed with a pistol grip configuration to maximize hand comfort during programming. The way it fits in the hand also lends itself to proper antenna alignment to the WVC Controller during transmitting, which is a vertical alignment. It also fits easily into a back pocket for easy transport.

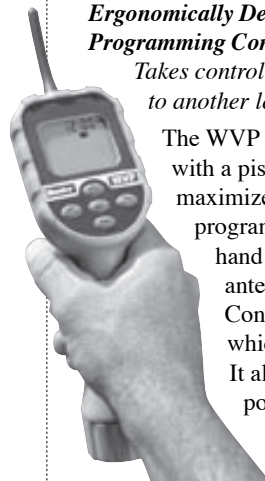

## PRODUCT FEATURES AND BENEFITS *(continued)*

### **Confirmation of Information Sent to the Controller...**

*Take the guesswork out of programming interchange*

“Did the program download or not?” Hunter understands the frustrations of users of remote controlled devices. The WVP indicates a successful contact and download with the WVC with two short audible beeps. If a contact was not successful, the WVP will also inform the user with one long sustained tone.

### **Waterproof Button Keypad...**

*Full overlay means rugged reliability*

With a waterproof overlay protecting the faceplate buttons, this unit can be carried into the field where it will get wet. The WVP



transmitter is as easy to program as other user-friendly Hunter controllers, like the Hunter ICC, Pro-C or EC. There are a total of five intuitive programming buttons that are utilized to provide a sophisticated program to any WVC controller.

### **Battery Life Status Indicator...**

*Low battery warning*

How much useful battery life is left? For battery-powered controllers produced in the past, the answer has always been, “I don’t know.” With Hunter’s battery-powered WVP Programmer, you always know the battery’s life, in both the WVC and the WVP, because of a battery consumption icon in the LCD display. Now you have the option of replacing the battery only when it actually needs replacing and not before, saving both time and money.



### **Independent Station Programming...**

*Different watering requirements are met with ease*

The battery-powered WVP Programmer allows for varied irrigation applications using independent programming for each zone.

This means that each valve is set up with its own start time, run time, and day schedule. This important feature can be used for various types of plants that have completely separate watering requirements, such as turf or shrubs and trees/shrubs on drip. Plus, each zone has the ability to water up to nine start times per day. The user has complete flexibility with watering schedules for new seed or sod lawns, multiple cycles for low infiltration-rate soils, slopes, morning or evening irrigation and other watering window restrictions.

### **Up to Nine Start Times Available...**

*Special watering requirements for new landscapes or slopes are accounted for*

You are in complete control when it comes to programming irrigation starts in the WVP. As with all Hunter controllers, setting the start time is as simple as pushing the up or down arrow buttons to the desired time. With its nine available start times, the WVP offers the flexible watering schedules needed for establishing new turf, irrigating steep slopes that require multiple starts to prevent erosion.

### **One Touch Manual Start...**

*Simple operation for a quick watering check of zones*

A feature that Hunter has incorporated into the WVP Programmer is called the One Touch Manual Start. It increases the user-friendliness of the controller by using fewer steps to activate the zone. This feature is great when extra watering is needed but you don’t want to spend time putting in a new program. When the time of day and battery indicator are showing in the display, push the right arrow button  to activate the zone. Squeeze the Transmit/Receive button on the WVP and a signal will be sent to turn the station on.



## **Choice of Independent Day Scheduling Options...**



*Days of the week or 31-day interval for maximum flexibility*



The day schedule may be set up independently for each of the stations. For each station, the choice of Day of the Week or a watering interval up to 31 days apart may be selected. This allows the user to water on certain days of the week such as Monday, Wednesday and Friday or water on a repeating day cycle (interval) such as every fifth day, making it ideal for drip irrigation.

## **Programmable 0-7 Day Rain Delay...**

*No need to return to the controller after it stops raining*

The battery-powered controller allows you to turn off the controller for a predetermined period of time (0-7 days) during rainy weather. After the specified period has elapsed, the controller will return to automatic mode and water as scheduled. This delay feature is very convenient in residential or commercial systems because when the operator uses this delay feature; there's no need to worry about remembering to go back and turn it on. This delay is accessed by pushing the return button  until the sprinkler off symbol is showing, then pushing the  button to the number of days of delay.

## **Up to Four Hour Run Times...**

*Allows accurate watering for all types of plant material*

Up to four hours of run time can be programmed in one-minute increments. The factory default is set at 0 minutes to keep the valve from operating before programming. The battery-powered controller will keep the run time within its memory after programming, even during battery replacement using its non-volatile memory.

## **Multi-language Capability...**

*Program controller in four languages*

These battery-powered controllers have integrated international requirements into

their design. Each unit uses internationally recognized icons. Instructions are affixed to the back of the unit in four different languages: English, Spanish, French and Italian.

## **AM/PM or 24-Hour Clock Settings...**

*Choose your favorite method of designating time*

The WVP allows the user to select the option of operating the controller in an AM/PM



mode or 24-hour mode. In most markets around the world, the 24-hour mode is the most common means of designating time, while in the U.S. market customers most often utilize an AM/PM mode.



The WVP was designed to meet the needs and provide for convenient ease of programming for all Hunter customers worldwide.

## **Automated Chronological Ordering of Start Times**

*No more "phantom" starts!*

When more than one start time is entered into the WVP, in any order of time sequence, the Programmer will automatically shift the start times into ascending order from the earliest start time to the latest start time. The WVP will also shift or move start times up the cue if times were inadvertently added after empty start time slots (up to 9 slots). For example, after programming is complete the Programmer will automatically fill the Start #1 slot first, and then the #2 slot second and so on, making it easier for the user to recheck the times. No "phantom" starts will occur from a start time buried deep in the program.

## **2-Year Warranty...**

*Hunter Industries backs up the products.*

A full two-year warranty by Hunter communicates to our customers that the WVP programmer stands up to the environment. The end-user can be assured of a quality product with a guarantee of dependable operation.

## PRODUCT COMPARISON

### Remote Programmable Battery Powered Controllers

Features	HUNTER® WVC WIRELESS	NELSON® SOLORAIN™ WIRELESS	RAIN BIRD® TBOS	IRRITROL® IBOC 300
Wireless, Radio Controlled Operation	✓	requires radio interface	requires radio interface	
Interface has Large LCD with Interactive Icons	✓	✓	✓	
Digital Push Button/Keypad Programming	✓	✓	✓	✓
Remote Programming with Handheld Transmitter	✓	✓	corded	✓
Maximum Distance from Controller to Programmer	100'	20'	2'	10'
No Special Wireless Radio Interfaces Needed	✓	radio interface	radio interface	
Type of Battery	9-volt alkaline	9-volt alkaline	9-volt alkaline	custom battery
Three Controller Mounting Options, Including Solenoid, Valve Box Wall or PVC Tube	✓	solenoid only	wall only	solenoid only
Multiple Valves Operated from One Controller	✓	✓	✓	
Battery Life Status Indicator	✓	✓	✓	✓
Maximum Distance Valve Located from Controller Using #14 UL Wire	100'	30'	80'	n/a
Non-Volatile Program Memory	✓			
Standard Weather Sensor (switch type) Compatible	✓			
Multi-language Capability	✓	✓		✓
Manual On/Off	✓	✓	✓	
Manual Start	✓	✓	✓	
Independent Station Programming	✓	✓	A, B, C programs	✓
Days-of-the-Week Programming	✓	✓	✓	✓
Interval Programming	31 days	14 days	7 days	7 days
AM/PM or 24 Hour Clock Settings	✓	✓	✓	
Waterproof Depth	12'	6'	6'	
Max. Station Run Time per Start	4 hrs	24 hrs	12 hrs	23 hrs 59 mins
Valve Starts per Day	9	16	8	3
Warranty Period	2 years	2 years	2 years	1 year
Maximum Operating Pressure	220 PSI	not listed	150 PSI	150 PSI

Rain Bird® is a registered trademark of Rain Bird Sprinkler Manufacturing Corporation  
Nelson® is a registered trademark of L. R. Nelson Corporation

# Wireless Valve System

## TECHNICAL INFORMATION

### DIMENSIONS

WVC – 3.25" D x 5" H

WVP – 3" W x 11.5" L x 2" H

### OPERATING SPECIFICATIONS

- Station run time: 0 to 240 minutes in 1-minute increments
- Start times: 9 per day
- Day of the week calendar
- Interval watering
- AM/PM or 24-hour clock option
- Start time stacking
- One button manual start and advance
- Programmable rain delay for 1 to 7 days

### ELECTRICAL SPECIFICATIONS

- Solenoids: Operates 6 to 9-volt DC latching solenoids
- Hunter DC Solenoid Latching Part: #458200
- Battery: Standard 9-volt alkaline battery (not included), one year minimum life. Battery not required for program backup.
- Memory: Non-volatile for program data
- Weather sensor compatible
- Frequency of operation: 900 MHz ISM band (U.S./Aust.) 868 MHz (Europe)

## PRODUCT EXPLANATION

### SPECIFICATION GUIDE

EXAMPLE: **WVC - 200**

MODEL	FEATURES	OPTIONS
WVC	200 = 2-Station Controller (Solenoid(s) Sold Separately) 400 = 4-Station Controller (Solenoid(s) Sold Separately)	E = Europe and Other Markets
WVP	Wireless Valve Programmer	

Consult with factory for compatibility in export markets.  
DC Latching Solenoid (P/N 458200)

## WVC COMPONENTS

This section provides a brief overview of some of the components of the WVC. Each item will be discussed in further detail later, however, this section can be helpful in getting acquainted with the different options available.

1. **WVC Body** – The WVC controller is designed to be dirt tolerant, waterproof, and submersible to 12 feet.
2. **External Antennae** – Flexible rubber antennae for radio communication.
3. **9-Volt Battery Holder** – The WVC is designed to operate on a single 9-volt alkaline battery. The battery easily snaps into the battery holder.
4. **Wires for DC Latching Solenoids** – 24" leads are provided for wiring DC latching solenoids. The overlay on the WVC provides station identification.
5. **Weather Sensor Wires** – A Hunter Rain-Clik™ or other Hunter weather sensor can be connected to the WVC.
6. **Valve Mounting Clip** – Allows the WVC to be mounted directly on any Hunter valve. The clip can also be used in conjunction with the Universal Mounting Adapter.
7. **Universal Mounting Adapter** – Allows for alternate methods of mounting the WVC. It can be used to mount the WVC to the side of the valve box or mounted on a ½" (13 mm) diameter section of plastic pipe.
8. **LED Indicator** – Used when setting WVC address.

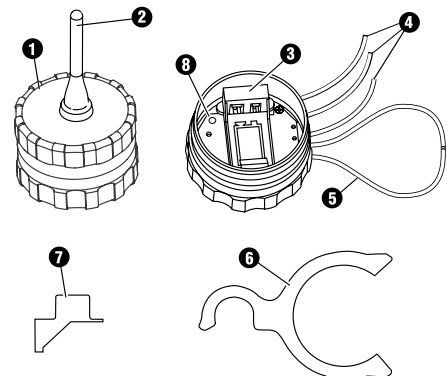

## WVP COMPONENTS

This section provides a brief overview of some of the components on the WVP. Each item will be discussed in further detail later, however, this section can be helpful in getting acquainted with the different options available. A key feature of the WVP is its clear, easy-to-use push button design that makes programming a snap. All essential keypad functions are clearly marked to avoid confusion that's characteristic with many other battery-powered controllers.

### Large LCD on the Programmer with Interactive Icons...

#### Internationally recognized programming icons

The large LCD display on the WVP with its interactive icons simplifies programming by using internationally recognized symbols for programming functions. Also, the display is easy to read and verify, making the entries easy to understand in any language.

#### LCD Display (Figure 1)

1. **Main Display** – Indicates all programmed information.
2. **Station Number** – Indicates the station number being programmed.
3. **Current Time/Day** – Icon indicates when current day and clock are being set.
4. **Run Times** – Icon indicates when Run Times are being set. Allows user to set run times from 1 minute to 4 hours.
5. **Start Times** – Icon indicates when Start Times are being set. Allows the user to set 1 to 9 start times.
6. **Start Time Number** – Indicates the start time number from 1 to 9.
7. **Water Days** – Allows the user to select individual days to water or a selected number of days between waterings (interval).
8. **Crossed Rain Drop** – Indicates that watering will NOT occur on a selected day.
9. **Crossed Sprinkler** – Indicates that watering is suspended.

10. **Flashing Sprinkler** – Indicates when watering is occurring.
11. **Calendar** – Indicates interval watering schedule is being programmed. Allows the user to program 1 to 31 days between waterings.
12. **Battery Status** – Indicates the remaining life of the battery.
13. **Manual Watering** – Icon indicates when manual watering is programmed. Allows the user to activate the station manually.
14. **Communication Occurring** – Segments will display in sequence when initial communication is being made with the WVC.
15. **Identification Code** – A unique ID to establish radio contact with an individual WVC.
16. **Transmit** – Arrow indicates that data is to be transmitted to the WVC.
17. **Receive** – Arrow indicates that data is to be retrieved from the WVC.
18. **No Contact** – Indicates that no contact was made with the WVC.

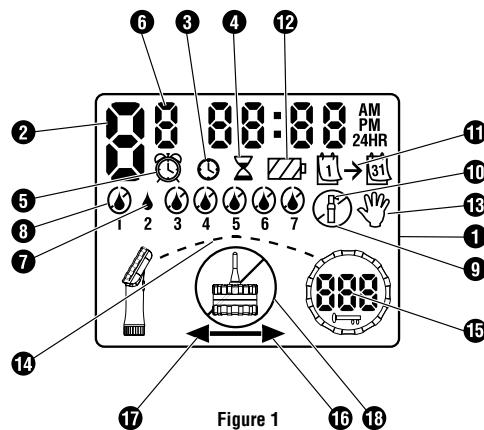

# Wireless Valve System

## WVC INSTALLATION

### Other Components (Figure 2)

19. **Transmit/Receive Button** – Transmit/Retrieve program information.
20. **Battery Compartment** – Accepts standard 9-volt alkaline battery.
21. **External Antennae** – Flexible external antennae.

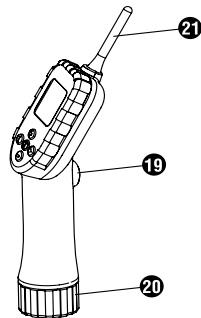

Figure 2

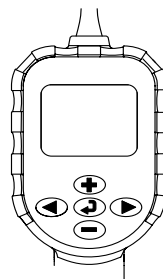

Figure 3

### Control Buttons (Figure 3)

- + Button** – Increases the selected flashing display.
- Button** – Decreases the selected flashing display.
- ▶ Button** – Selects programming function.
- ▶ Button** – Advances the selected flashing display to the next item.
- ◀ Button** – Navigates the selected flashing display back to the previous item.

### Installing the Battery

The WVC uses a standard 9-volt alkaline battery to operate the valve and program the controller. The battery life is affected by the number of valve actuations, along with the distance the solenoids are from the controller. Under normal conditions the battery should provide at least one full year of service.



NOTE: The WVC has non-volatile memory that allows the battery to be removed without losing any program information.

### To install the battery:

1. Unscrew the rear half of the WVC body to gain access to the battery compartment.

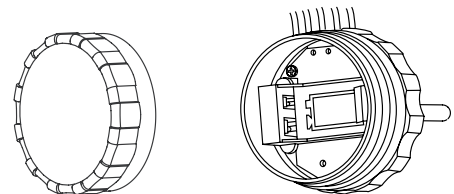

2. Snap the battery into the battery holder.

NOTE: The battery holder is designed so that the battery can only be inserted one way.

3. Make sure no water is inside the battery compartment. Screw the WVC body halves together to seal the compartment.

### Wiring DC Latching Solenoids to the WVC

Leads are provided to attach a Hunter DC latching solenoid or other two-wire, DC latching solenoids to the WVC.

Hunter DC latching solenoids have two leads: one colored black and the other red. To connect DC latching solenoids:

1. Select the appropriate station wire on the WVC (Note: Station numbers are identified on the WVC overlay) and strip away ½" (13 mm) of insulation from the wire.
2. Remove ½" (13 mm) of insulation from the common wire (black wire) on the WVC.

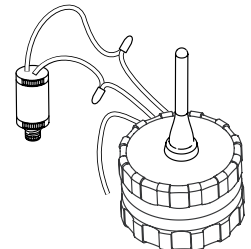

## WVC INSTALLATION (continued)

- Remove ½" (13 mm) of insulation from the solenoid wires and twist the red and black leads from the solenoid to the WVC as shown in the figure below.
- Make sure that waterproof connectors are used to secure all wire connections.



NOTE: The maximum recommended distance from the WVC to any Hunter DC latching solenoid is approximately 100 feet. Long distances between the WVC and the DC latching solenoid will reduce the 9-volt battery life.

### Radio Communication

All programming and manual operations with the WVC can be controlled with the WVP. Actual performance varies depending upon the installation and the surrounding terrain. The WVP can send/retrieve data to/from the WVC up to 100 ft. with the WVC installed in the valve box below ground level. Radio range increases when the WVC is installed above ground. (Refer to the WVP Owner's Manual regarding radio communication.)

### Addressing the WVC with the WVP (WVP required to perform this function)

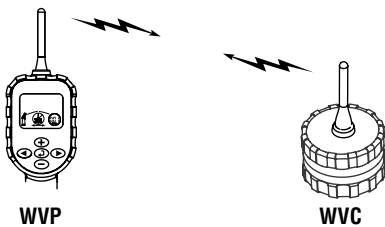

Each WVC controller requires a unique identification number for proper radio operation with the WVP. Setting unique addresses for each WVC allows for separate radio programming and manual operations with individual WVC controllers even though other controllers may be in the surrounding area. The unique address is a 3-digit number from 000 to 999. Once the address is set, you must remember the ID for future operation. (Refer to the WVP Owner's Manual for detailed programming instructions.)

### Below Ground Installation

For maximum radio range, position WVC as high as possible.

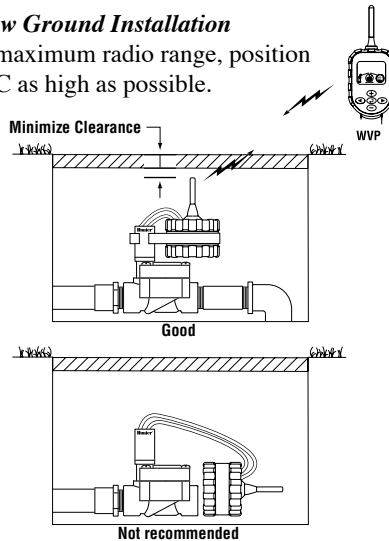

### To Set the Unique Address on the WVC:

- Press the Transmit/Receive button on the WVP to enter the communications mode. (Lower portion of display.)
- Use the  $\oplus$  and  $\ominus$  buttons to change the 3-digit identification number. Use the  $\triangleright$  button to make sure that the WVP is in the transmit mode with the arrow on the display pointing towards the address icon  $\text{Ⓜ}$  (see figure).
- Unscrew the rear half of the WVC body to gain access to the battery compartment.
- Install a standard 9-volt alkaline battery into the battery holder (see Connecting the Battery).
- Wait for the red light inside the battery compartment to come on, this may take 10-15 seconds.
- Immediately press and hold the Transmit/Receive button on the WVP. The WVP will beep twice when transmission commences. Release the button.
- The WVP will beep twice again when the identification number has been learned by the WVC.

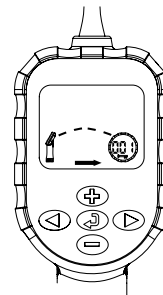

8. If the WVP illuminates the failed to communicate icon  then start over from step 4.



NOTE: If no WVP transmission takes place after the red light on the WVC comes on, the WVC will turn this light back off (after 20 seconds) and revert back to the address already programmed into the WVC.

### Mounting the WVC to a Hunter Valve

The WVC can easily be mounted on any Hunter plastic valve. A special designed valve mounting clip makes installation a snap.

#### To Mount the WVC to a Valve (Figure 1):

1. Unscrew the existing solenoid from the valve.
2. Screw the WVC latching solenoid into the valve bonnet.
3. Attach the large end of the valve mounting clip to the middle of the WVC body.
4. Snap the small end of the valve mounting clip to the solenoid.

NOTE: The total length of wire from the WVC to the solenoid should not exceed 100 ft.

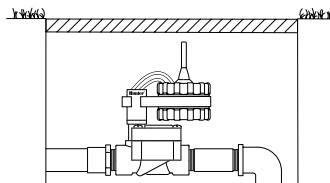

Figure 1

### Alternate Mounting Methods

A universal mounting clip and mounting adapter are also provided with the WVC. These allow for alternate methods of mounting the controller either to the side of the valve box or stake mounted within the valve box.

#### Valve Box Mounting Method (Figure 2)

1. Position the universal mounting adapter on the side of the valve box. Make sure that the bracket is positioned so that the controller does not interfere with the top of the valve box cover.
2. Drive two screws to secure the adapter to the side of the valve box.

3. Attach the WVC to the mounting clip and slide it on the end of the mounting adapter.

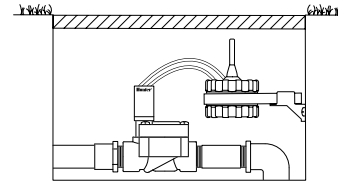

Figure 2

#### Stake Mounting Method (Figure 3)

The universal mounting adapter can also be used to stake mount the WVC.

1. Cut a section of 1/2" (13 mm) diameter plastic pipe.
2. Drive the pipe into the ground inside the valve box to the desired height of the controller.
3. Slip the mounting adapter on top of the pipe.
4. Attach the WVC to the mounting clip and slide onto the adapter.

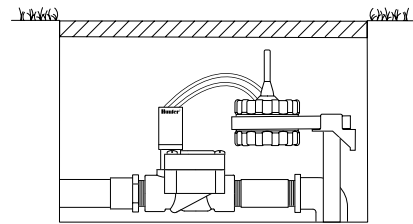

Figure 3

### Connecting a Weather Sensor

A Hunter Mini-Clik® rain sensor or other micro-switch type weather sensor can be connected to the WVC. The purpose of this sensor is to stop watering when weather conditions dictate.

#### To Connect a Weather Sensor to the WVC (Figure 4):

1. Cut the yellow wire loop attached to the WVC at approximately the middle of the loop.
2. Remove approximately 1/2" (13 mm) of insulation from each wire. Attach each wire to each of the wires of the weather sensor.

## WVC INSTALLATION (continued)

- Secure wire connections with waterproof connectors.

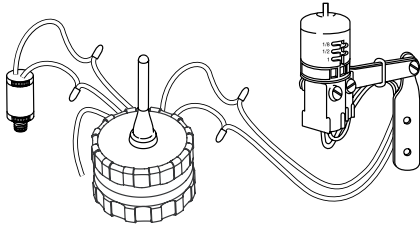

Figure 4

## WVP INSTALLATION

### Installing the Battery

The WVP is powered by a standard 9-volt alkaline battery. Under normal conditions the battery should provide at least one full year of service.



**NOTE:** The WVP has non-volatile memory which allows for the battery to be removed without losing any program information.

### To install the battery (Figure 5):

- Unscrew the battery cap on the bottom of the handle to gain access to the battery compartment.
- Attach the battery to the battery clip and slide the battery into the battery compartment with the connectors toward the inside of the WVP handle.
- Reinstall the battery cap.

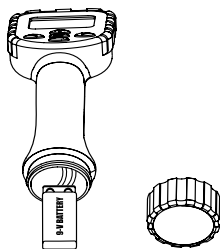

Figure 5

The WVP can now be used to program your controller.

## PROGRAMMING THE CONTROLLER

### WVP Display

Before you begin programming the WVP, take some time to learn about the features available and how program information is created. The large LCD display on the WVP is split into two areas: Programming and Communication. The upper portion of the LCD display is used for creating or changing program related information. The lower portion of the display is used to establish radio contact with WVC controllers, send/retrieve program information, conduct manual watering and establish unique addresses for each controller.

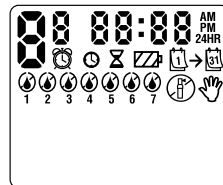

Programming Mode

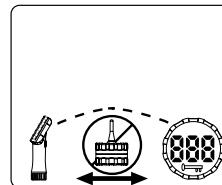

Communication Mode

While in the programming mode, pressing the button will step through the programming modes of operation in the following order: 1) Current Time/Date, 2) Set Time/Date, 3) Set Watering Start Times, 4) Set Run Times, 5) Set Water Days, and 6) Off Mode.

When creating or changing program information, the flashing portion of the display can be changed by pressing the or buttons. To change something that is not flashing, press the or buttons until the desired field is flashing.











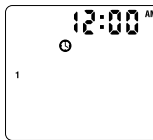

The Transmit/Receive button on the handle of the WVP is used for navigating to and from the communication function on the display, initiating communication with a WVC, setting the WVC unique identification code, and transmitting/receiving data with a WVC. If the Transmit/Receive button is pressed at any time during one of the programming modes mentioned above, then the communication mode will be displayed.

After one minute of inactivity the WVP display will go blank to conserve battery power. Press any button to reactivate the display.

## Setup the WVP

The WVP is simple to program. The easy-to-understand push button design allows you to step through the process of programming and activate manual watering with the press of a button. Prior to performing any programming, you need to set up your WVP with the current date and time.

## Setting the Date and Time

1. While in the programming mode, press the  button until the Set Current Time/Day icon is displayed. 
2. Hours will be flashing. Press the  or  button to change the hour shown on the display. Press the  to proceed to setting the minutes.
3. Minutes will be flashing. Use the  or  button to change the minutes shown on the display. Press the  to proceed to select AM, PM or 24 hour time.
4. The time will be displayed, and the time of day flashing. Press the  or  button to select AM, PM or 24 hour. Press the  to proceed to setting the day of the week.
5. The number 1 will be flashing indicating the first day of the week. Press the  or  buttons to select the day of the week (1 through 7) corresponding to the day.











Your WVP is ready to use to program your WVC.

## Programming with the WVP



The WVP utilizes an independent station programming method for programming your WVC controllers. Independent station programming requires that for each station being programmed, you need to program Start Time(s), Run Time and Water Day(s). The  button allows you to quickly navigate among programming options.

## Setting Watering Start Times

1. Push the  button until the Start Watering Times icon is displayed. The display will show the station number, start time number and the start time.



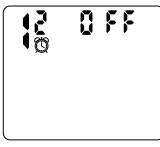

2. Press the  button to navigate to the station number. Use the  or  button to change the station number. 
3. Press the  to navigate to the start time number. Use the  or  button to change the start time number.
4. Press the  to navigate to the start time. Use the  or  button to enter a start time (the start time will advance in 15 minute increments). Hold either button down for 1 second to change times rapidly.

## Eliminating a Start Time

With the display in the watering Start Time mode, push the  or  button until you reach 12:00 AM (midnight). From here push the  button once to reach the OFF position. 

*NOTE: If the WVC has all 9 start times turned off, then the controller is off.*

## Setting the Run Time (Length of Watering)

1. Press the  button until the Run Time icon is displayed.
2. The display will show the station number and the last run time entered will be blinking. 
3. Use the  or  button to change the station run time on the display from 1 minute to 4 hours.
4. Use the  button to navigate the next station.
5. Repeat steps 3 and 4 for each station.

## Setting Days to Water

1. Push the  button until the Water Days icon is displayed.
2. For each station, the WVP will display either specific days to water or interval watering.

## PROGRAMMING THE CONTROLLER (continued)

### Selecting Specific Days of the Week to Water

The controller will display the station number and 7 days of the week with a ♣ icon or a ☉ icon above the numbered day. The ♣ icon would represent an “On” water day, while the ☉ icon would represent an “Off” watering day.

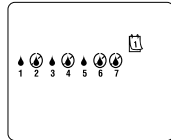

1. Press the ⏪ button to navigate to the desired station.
2. With the ♣ cursor on a specific day (the cursor always starts with 1), press the ☉ button to activate a particular day of the week to water. Press the ⏪ button to cancel watering for that day. After pressing a button the cursor automatically advances to the next day.
3. Repeat step 1 until all desired days have been selected. The selected days will show with a ♣ to indicate their status ON. The last ♣ is the last watering day for the program.
4. Press the ⏪ button to navigate to the next station.
5. Repeat steps 1 through 3 for each station.



**NOTE:** If interval watering is selected, make sure the interval mode is displayed prior to navigating to the next station.

### Selecting Interval Watering

With this option you can select interval watering from 1 to 31 days.

1. Use the ⏪ button to navigate to the desired station.
2. With the ♣ cursor on day 7, press the ⏩ button until the interval watering icon ☉→☉ will be displayed along with the interval (flashing).
3. Press the ☉ or ⏪ button to select the number of days between watering days (1 to 31). This is called the interval. (Pressing the ⏩ at anytime during the interval setup will advance back to specific days of the week to water.)
4. Use the ⏪ button to advance to the next station number.

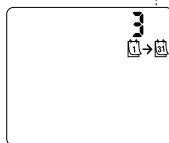

The controller will water at the next Start Time and will then water at the interval programmed.

### Transmitting/Receiving Data

All program information and manual watering is conducted with the WVP and individual WVC controllers using radio signals. Under normal conditions, these operations can be conducted up to 100 feet from the controller. The transmit/receive button on the handle of the WVP is used to transmit or receive data.

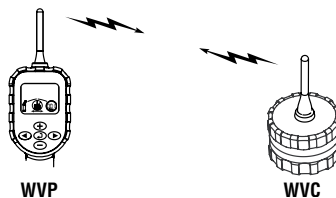

### Entering the WVC Identification Code

Each WVC controller has a unique 3-digit identification code that is established during the installation of the controller. This unique code allows for added security and radio operation with individual controllers on a site that has multiple WVC controllers. To establish radio contact with a WVC, you must know the unique identification code that was established during the initial setup of the WVC controller (refer to page 30 for information on setting or changing the identification code for your controller).

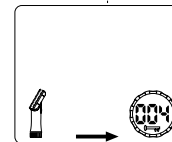

1. Press the Transmit/Receive button on the WVP handle. The lower portion of the display will illuminate. The Transmit/Receive arrow will be flashing.
2. Use the ☉ or ⏪ button to enter the unique WVC identification code from 0 to 999. You can now establish radio contact with the WVC.

### Transmitting Programs

Once the WVC 3-digit identification code is entered into the WVP:

1. Use the ⏩ button to select the transmit function (the → arrow will be flashing).

2. Squeeze the Transmit/Receive button on the handle of the WVP for 2 seconds. The WVP will beep twice indicating that communication is taking place.

3. After a few seconds, dashed lines will appear on the display indicating that radio communication is being made with the WVC. When the last dashed line illuminates, data transmission is completed and the WVP will beep twice indicating that data transmission was successful.

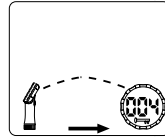

If for any reason that radio connection was not successful, the WVP will produce a single two second beep and the No Contact icon (👎) will be displayed in the middle of the display for a brief period.

If you are experiencing problems contacting the WVC, make sure you are using the correct identification code. If communication problems persist, try moving closer to the WVC to improve radio contact. The range of the signal is 100 feet with the WVC installed in the valve box. Actual performance varies depending upon the installation and the surrounding terrain.

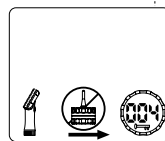

### Retrieving Programs

Once the WVC 3-digit identification code is entered into the WVP:

1. Press the (▶) button on the WVP to select the receive function (the ← will be flashing).
2. Squeeze the Transmit/Receive button on the handle of the WVP for 2 seconds. The WVP will beep twice indicating that communication is taking place.
3. Dashed lines will appear on the display indicating that radio communication is being made with the WVC. When the last dashed line illuminates, data transmission is completed and the WVP will beep twice indicating that data transmission was successful.

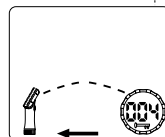

4. All current program information and battery life status from the WVC can now be reviewed with the WVP, by squeezing the Transmit/Receive button once, which returns the unit to the programming mode.

### Manual Watering Operation

To activate a Manual Watering:

1. Press the (▶) button once to display the Current Time/Day icon.
2. Press and hold the (▶) button to display the Manual Watering icon. Station number 1 will be displayed along with the manual run time.
3. Use the (▶) button to navigate to the station you would like to operate manually.
4. Use the (+) or (-) button to adjust the manual water run time from 1 minute to 4 hours.
5. While in the Manual Watering mode, squeeze and hold the Transmit/Receive button for 2 seconds to initiate the watering cycle.

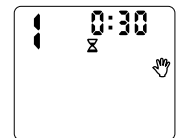

*NOTE: If no buttons are pressed within 5 seconds, the WVP will revert to the Current Time/Day.*

6. Repeat steps 2 through 5 for each station you would like to operate manually.

To suspend Manual Watering:

1. With the current time/day showing in the display, press and hold the (▶) button to enter the manual off mode.
2. Use the (▶) button to navigate to the station you would like to turn off.
3. While in the manual off mode, squeeze and hold the Transmit/Receive button for 2 seconds to deactivate the manual cycle for the station selected.
4. Repeat steps 1 through 3 to turn off additional stations.

## PROGRAMMING THE CONTROLLER (*continued*)

### System Off

The system off function will turn your WVC controller off, stopping all automatic watering until turned back on with your WVP.

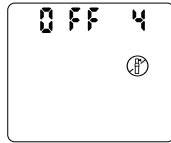

To turn the WVC off:

1. Use the button until the off icon is displayed. After flashing for a few seconds, the word "OFF" will appear in the display.
2. Squeeze the Transmit/Receive button on the WVP once to move to communication mode (lower part of LCD), use the and buttons to make sure the arrow is pointed toward the WVC icon, then squeeze and hold the Transmit/Receive button on the WVP. The WVP will beep twice indicating that the "OFF" command is being sent to the WVC. It will beep twice again indicating the command was successfully received by the WVC.

To turn the WVC on:

1. While in the programming mode (upper part of the LCD), press the button until the current time and day is displayed.
2. Squeeze the Transmit/Receive button once to move to communication mode (lower part of LCD), use the and buttons to make sure the arrow is pointed toward the WVC, then squeeze and hold the Transmit/Receive button on the WVP. The WVP will beep twice indicating that the "ON" command has been sent to the WVC. It will beep twice again indicating the command was successfully received by the WVC.

**Tip:** Use the retrieve program function (see page 33) to identify if WVC has been turned off in the field. After retrieving the program, a controller that has been turned off will display the system off icon on the WVP display.

### Programmable Rain Off

This feature permits the user to stop all programmed waterings for a designated period from 1 to 7 days. At the end of the programmable rain off period,

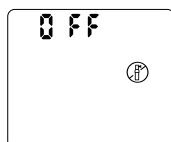

the controller will resume normal automatic operation.

1. Press the button until the System Off icon is displayed.
2. Press the button and a 1 will be displayed. The 1 will be blinking at this point.
3. Press the button as many times as needed to set the number of days off desired (up to 7).
4. Squeeze the Transmit/Receive button once to navigate to the communication mode.
5. Use the and buttons to make sure the arrow is pointed towards the WVC.
6. Squeeze and hold the Transmit/Receive button. The WVP will beep twice indicating the command is being sent to the WVC. It will beep twice again to indicate that the WVC has received the command.

### Battery Life Indicator

The battery life indicator icon is a quick way to determine the remaining life of the battery installed

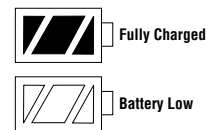

in either the WVP or any individual WVC controllers. The WVP will continually show the status of its battery while the Current Time/Day is displayed. The WVP can also retrieve the battery life information from the WVC when programs are retrieved (see Retrieving Programs). A fully charged battery will show all three segments of the battery dark. As the battery is expended, the segments will appear as outlines.

After retrieving battery life information from the WVC, the icon will display the information until the WVP LCD goes blank due to inactivity. The next time the WVP display comes on it will provide battery life information for the WVP.

## TROUBLESHOOTING

PROBLEM	CAUSES	SOLUTIONS
There is no display.	1. Display is off. 2. Battery is dead.	1. Press any button for 1 second. 2. Replace the battery.
Display indicates watering, but none is occurring.	1. No water pressure. 2. Faulty solenoid. 3. Faulty wire connections, if used.	1. Turn on main system supply. 2. Replace solenoid. 3. Check and replace wire connections.
Automatic irrigation does not start at start time.	1. Controller in System Off mode. 2. AM/PM of time of day not set correctly. 3. AM/PM of start time not set correctly. 4. Rain sensor is active. 5. Faulty rain sensor wire connections.	1. Verify that controller is on. 2. Correct AM/PM of time of day. 3. Correct AM/PM of start time. 4. Wait until the rain sensor is inactive or remove from system. 5. Check and replace wire connections.
Rain sensor does not suspend watering.	1. Rain sensor problem.	1. Verify proper operation of the rain sensor and wire connections.
Controller waters more than one time.	1. Too many start times have been entered.	1. One start time activates a complete cycle (see Setting Start Times).
No display on WVP.	1. Battery is dead.	1. Replace the battery.
No contact icon is displayed.	1. Wrong 3-digit WVC identification code entered. 2. Out of range. 3. Battery dead in WVC.	1. Reenter correct ID code in WVP and attempt to establish contact with WVC. 2. Move closer to WVC and attempt to establish contact. 3. Replace WVC battery.

## TRAINING MANUAL QUIZ

All of the answers to this quiz are contained in this training manual. Answers to the questions can be found on page 36.

- The Hunter SVC is a full featured \_\_\_\_\_ station \_\_\_\_\_-powered controller that is ideal for landscape sites without a readily accessible \_\_\_\_\_ power supply.
- The \_\_\_\_\_ battery that provides power to operate the valve solenoid will last \_\_\_\_\_ irrigation season even if the controller is programmed to operate every day, nine times per day.
- The SVC Controller has \_\_\_\_\_ solenoid attached to it with an \_\_\_\_\_ inch wire lead to the controller unit, making it programmable outside of the valve box.
- The SVC comes with a \_\_\_\_\_ that allows the user to easily attach the controller unit to the inside wall of the valve box.
- The SVC can be purchased as a stand alone controller unit that can be directly installed on any Hunter valve or as a kit that has a 1 inch Hunter PGV Valve with Flow Control with an SVC battery-powered controller unit preinstalled on it. The model number for this kit is \_\_\_\_\_.
- The LCD display on the unit utilizes \_\_\_\_\_ recognized symbols that provide for simple intuitive programming.
- If desired, the SVC can be installed up to \_\_\_\_\_ feet from the valve location by attaching 14 gauge wire from the wire leads of the solenoid to the controller unit wire leads.
- To hook up a sensor to the unit, the \_\_\_\_\_ wire that is attached to the SVC unit is attached to the wire leads of the sensor with waterproof connectors.

## TRAINING MANUAL QUIZ (continued)

9. The unit is programmable up to \_\_\_\_\_ start times, either day of the week or \_\_\_\_\_ day interval irrigation cycles and up to \_\_\_\_\_ hour run times and set time in either an \_\_\_\_\_ mode or 24-hour mode.
10. The SVC has a \_\_\_\_\_ memory so when the battery is changed the unit does not need to be re-programmed.
11. The SVC Controller unit is waterproof up to a submerged depth of \_\_\_\_\_ feet due to the double O-ring seal.
12. Instructions on how to operate the unit are adhered to the back of the SVC unit in multiple languages. The four languages are: \_\_\_\_\_, \_\_\_\_\_, \_\_\_\_\_ and \_\_\_\_\_.
13. If the display is not illuminated and there is battery power, the display will be activated by holding down \_\_\_\_\_ button for approximately \_\_\_\_\_ second.
14. The Hunter Wireless Valve System contains a Wireless Valve \_\_\_\_\_ (WVC) and a Wireless Valve \_\_\_\_\_ (WVP).
15. The WVC comes in \_\_\_\_\_ station and \_\_\_\_\_ station configurations.
16. The WVC can be programmed by the Wireless Valve Programmer up to \_\_\_\_\_ feet away.
17. The WVP confirms a successful download of the program to the WVC by \_\_\_\_\_ short audible beeps.
18. Each station in the unit has an \_\_\_\_\_ program which allows for maximum scheduling flexibility.
19. Both the SVC and WVC have a programmable rain delay from \_\_\_\_\_ to \_\_\_\_\_ days.
20. The WVC is the only \_\_\_\_\_ battery-powered controller that is \_\_\_\_\_ sensor compatible.
21. The WVC has an LCD display built into the unit. T or F

22. A flashing Sprinkler symbol on the LCD Display indicates that \_\_\_\_\_ is occurring.
23. Each WVC has a unique \_\_\_\_\_ so the WVP can communicate directly to a specific WVC without impacting another WVC within range.
24. Simple manual operation of the WVC/ WVP is accomplished by pushing the right arrow button. This feature is called "\_\_\_\_\_ Manual Start."

## QUIZ ANSWERS

1. single, battery, electrical (pg. 2) 2. 9-volt, one full (pg. 2) 3. DC latching, 24 (pg. 3) 4. wall/ pipe bracket (pg. 4) 5. SVC-100-VALVE (pg. 4) 6. internationally (pg. 5) 7. 100 (pg. 5) 8. yellow (pg. 5) 9. nine, 1-31, 4, AM/PM (pg. 7) 10. non-volatile (pg. 3) 11. twelve (12) (pg. 3) 12. English, Spanish, French and Italian (pg. 6) 13. any, one (pg. 13) 14. Controller, Programmer (pg. 14) 15. two, four (pg. 14) 16. 100 (pg. 14) 17. two (pg. 18) 18. independent (pg. 18) 19. 0, 7 (pg. 19) 20. multi-station, weather (pg. 20) 21. False, the WVP has the LCD display (pg. 22) 22. watering (pg. 22) 23. identification code (pg. 22, 24) 24. One Touch (pg. 18)