

# WVP

---

## Wireless Valve Programmer

Programmer for use with WVC  
Multi-Station Battery Powered  
Irrigation Controllers

Owner's Manual and  
Installation Instructions

**Hunter**<sup>®</sup>

**aquaspec**<sup>®</sup>  
0800 353 966  
[www.aquaspec.co.nz](http://www.aquaspec.co.nz)

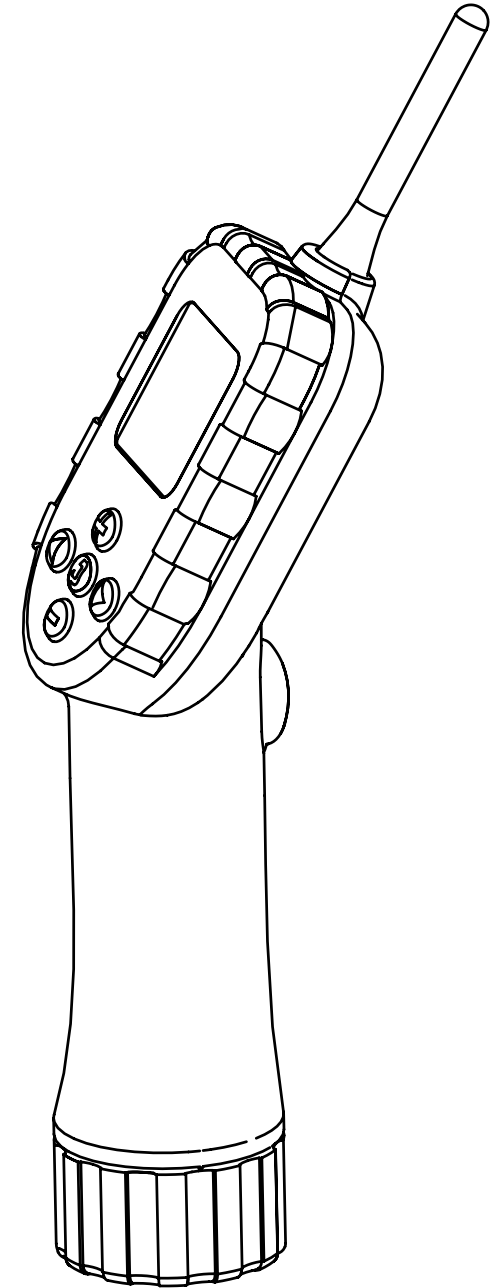



# **TABLE OF CONTENTS .....**

Introduction .....	1
WVP Components.....	2
WVP Features.....	5
Installing the Battery .....	6
WVP Display .....	7
Setting Up the WVP .....	8
Programming the WVP .....	8
Transmitting/Receiving Data.....	13
Battery Life Indicator .....	16
Troubleshooting Guide.....	17
FCC Notice .....	19



# **INTRODUCTION** .....

The Wireless Valve Programmer (WVP) is part of the Hunter wireless battery powered controller family. The WVP is a hand-held programmer that allows you to create watering programs and conduct manual operations with Hunter Wireless Valve Controllers (WVC) in the field. Because the WVP retrieves and transmits data via radio signals, you never have to open a valve box to check the status or program your controllers.

Hunter's wireless battery powered irrigation systems are ideal for commercial/municipal applications such as street and highway landscaping, medians, parks, construction sites, and other areas that do not have access to power.

The WVP can retrieve the current program and battery life status of individual WVC controllers. Programming and manual operations are conducted with the press of a button from up to 100 feet away from the WVC. The following instructions provide detailed information on using your WVP. Please refer to your WVC Owner's Manual for information on installing and setting up your WVC controllers.

# WVP COMPONENTS.....

This section provides a brief overview of some of the components on the WVP. Each item will be discussed in further detail later; however, this section can be helpful in getting acquainted with the different options available. A key feature of the WVP is its clear, easy-to-use push button design that makes programming a simple task. All essential keypad functions are clearly marked to avoid confusion that's characteristic with many other battery powered controllers.

## LCD Display (Figure 1)

1. **Main Display** – Indicates all programmed information.
2. **Station Number** – Indicates the station number being programmed.
3. **Current Time/Day** – Icon indicates when current day and clock are being set.
4. **Run Times** – Icon indicates when Run Times are being set. Allows user to set run times from 1 minute to 4 hours.
5. **Start Times** – Icon indicates when Start Times are being set. Allows the user to set 1 to 9 start times.

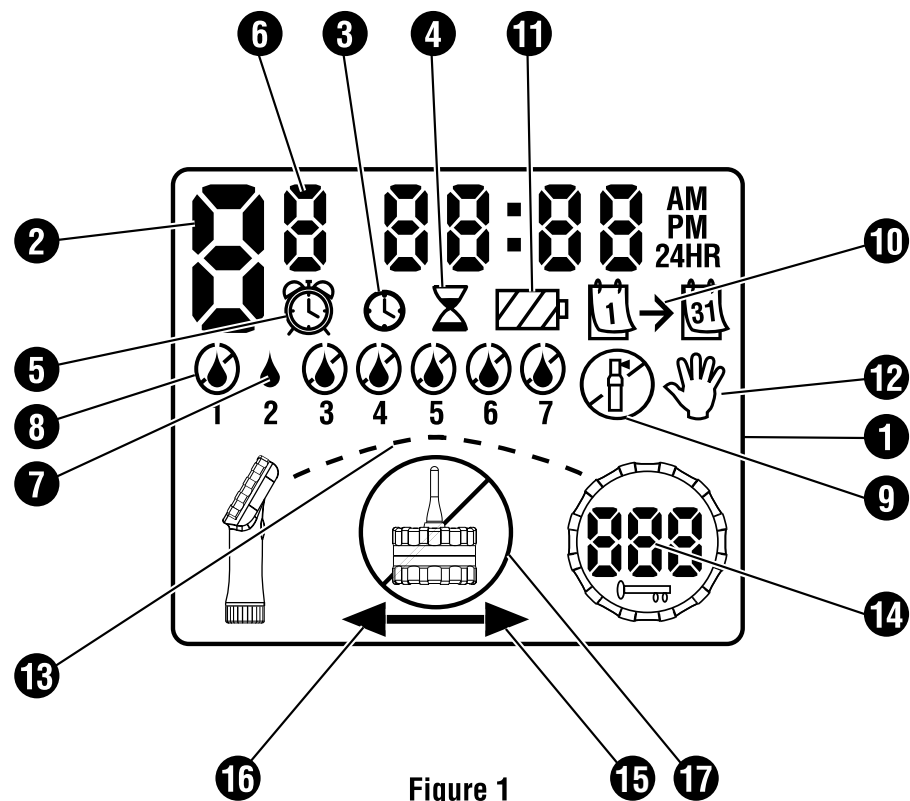

Figure 1

6. **Start Time Number** – Indicates the start time number from 1 to 9.
7. **Water Days** – Allows the user to select individual days to water or a selected number of days between waterings (interval).

8. **Crossed Rain Drop** – Indicates that watering will NOT occur on a selected day.
9. **Crossed Sprinkler** – Indicates that watering is suspended.
10. **Calendar** – Indicates interval watering schedule is being programmed. Allows the user to program 1 to 31 days between waterings.
11. **Battery Status** – Indicates the remaining life of the battery in the WVC.
12. **Manual Watering** – Icon indicates when manual watering is programmed. Allows the user to activate the station manually.
13. **Communication Occurring** – Segments will display in sequence when initial communication is being made with the WVC.
14. **Identification Code** – A unique ID to establish radio contact with an individual WVC.
15. **Transmit** – Arrow indicates that data is to be transmitted to the WVC.
16. **Receive** – Arrow indicates that data is to be retrieved from the WVC.

17. **No Contact** – Indicates that no contact was made with the WVC.

### Control Buttons (Figure 2)

- ⊕ **Button** – Increases the selected flashing display.
- ⊖ **Button** – Decreases the selected flashing display.
- ↻ **Button** – Selects programming function.
- ▶ **Button** – Advances the selected flashing display to the next item.
- ◀ **Button** – Navigates the selected flashing display back to the previous item.

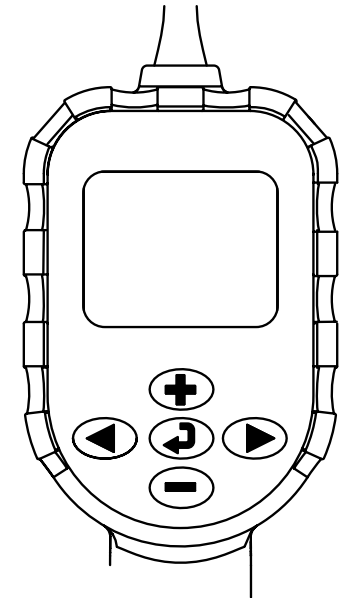

Figure 2

# WVP COMPONENTS (continued) .....

## Other Components (Figure 3)

- 18. **Transmit/Receive Button** – Transmit/Retrieve program information.
- 19. **Battery Compartment** – Accepts standard 9-volt alkaline battery.
- 20. **External Antennae** – Flexible external antennae for radio communication.

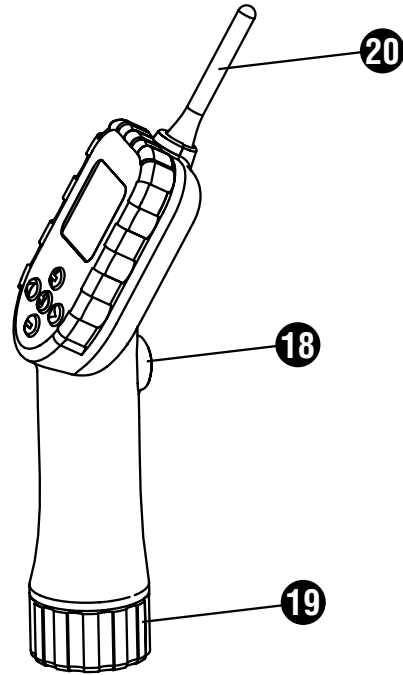

Figure 3

# **WVP FEATURES** .....

## **Some of the features of the WVP include:**

- Simple, push button programming
- Large Liquid Crystal Display (LCD) with easy to understand icons
- Radio communication WVC controllers up to 100 feet away
- Operates on standard 9-volt alkaline battery
- Days-of-the-week watering schedule
- Up to 9 start times per day
- Run times from 1 minute to 4 hours
- Manual watering
- Low battery status shows status of life of the battery in the WVP and WVC

# INSTALLING THE BATTERY.....

The WVP is powered by a standard 9-volt alkaline battery. Under normal conditions the battery should provide at least one full year of service.



**Note: The WVP has non-volatile memory which allows the battery to be removed without losing any program information.**

## To install the battery (Figure 4):

1. Unscrew the battery cap on the bottom of the handle to gain access to the battery compartment.
2. Snap the battery on to the connector and slide the battery into the battery compartment with the connector toward the inside of the WVP handle.
3. Reinstall the battery cap.

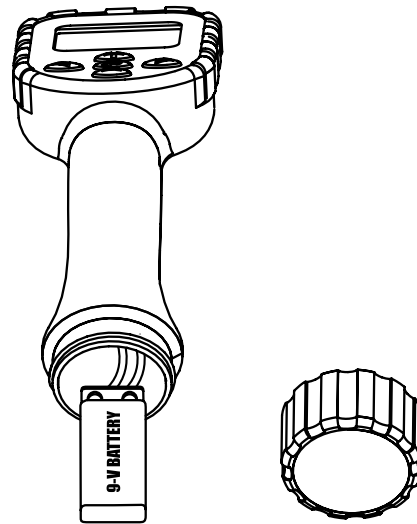
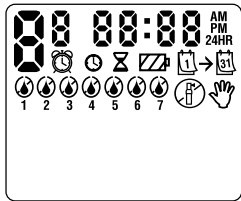

Figure 4

The WVP can now be used to program your controller.

## WVP DISPLAY

Before you begin programming the WVP, take some time to learn about the features available and how program information is created. The large LCD display on the WVP is split into two areas: Programming and Communication. The upper portion of the LCD display is used for creating or changing program related information. The lower portion of the display is used to establish radio contact with WVC controllers, send/retrieve program information, conduct manual watering, and establish unique addresses for each controller.





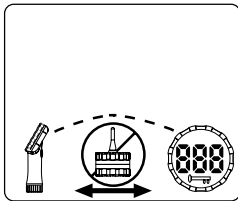

Programming



Communication

Pressing the  button will step through the programming modes of operation in the following order: 1) Current Time/Date, 2) Set Time/Date, 3) Set Watering Start Times, 4) Set Run Times, 5) Set Water Days, and 6) System Off Mode.

When creating or changing program information, the flashing portion of the display can be changed by pressing the  or  buttons. To change something that is not flashing, press the  or  buttons until the desired field is flashing.



The Transmit/Receive button on the handle of the WVP is used for navigating to and from the communication function on the display, initiating communication with a WVC, setting the WVC unique identification code, and transmitting/receiving data with a WVC. If the Transmit/Receive button is pressed at any time during one of the programming modes mentioned above, then the lower half or communication mode of the display will be activated. Pressing it again returns the unit to the programming mode.

After one minute of inactivity the WVP display will go blank to conserve battery power. Press any button to reactivate the display.







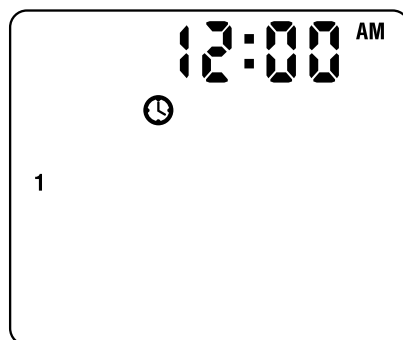

## SETTING UP THE WVP .....

The WVP is simple to program. The easy-to-understand push button design allows you to step through the process of programming and activate manual watering with the press of a button. Prior to performing any programming, you need to set up your WVP with the current date and time.

### Setting the Date and Time

1. While in the programming mode, press the  button until the Set Current Time/Day icon is displayed.
2. Hours will be flashing. Press the  or  button to change the hour shown on the display.



3. Press the  to proceed to setting the minutes.
3. Minutes will be flashing. Use the  or  button to change the minutes shown on the display. Press the  to proceed to select AM, PM or 24 hour time.
4. The time will be displayed, and the time of day flashing. Press the  or  button to select AM, PM or 24 hour. Press the  to proceed to setting the day of the week.
5. The number 1 will be flashing indicating the first day of the week. Press the  or  buttons to select the day of the week (1 through 7) corresponding to the day.

Your WVP is ready to use to program your WVC.

## PROGRAMMING THE WVP .....









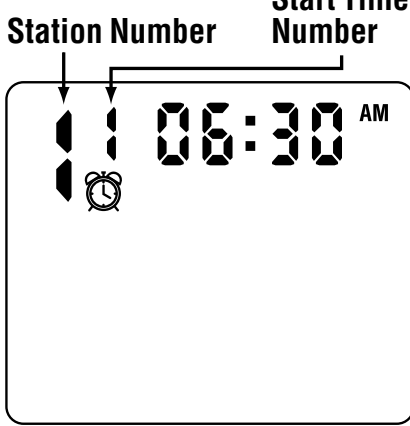

The WVP utilizes an independent station programming method for establishing watering schedules. Each station on a single WVC controller will run independent of one another. Stations can also be programmed to run simultaneously. When programming a new watering schedule, each station must be programmed with its own start time, run time, and water day(s). The following steps provide

additional information on programming your controller(s).

The  button allows you to quickly navigate among the programming modes. A programming icon will indicate each of the following programming modes:

 Current Time/Date,  Set Start Time,  Set Run Time,  Set Water Days, and  System Off.



## Setting Watering Start Times

1. Push the  button until the Start Watering Times icon is displayed. The display will show the station number, (larger size number to the left of the Start Time icon) start time number (smaller size number to the right of the station number) and the start time. The start time will be flashing.  

2. Press the  button to navigate to the station number. Use the  or  button to change the station number
3. Press the  button to navigate to the start time number. Use the  or  button to change the start time number.
4. Press the  button to navigate to the start time. Use the  or  button to enter a start time (the start time will advance in 15 minute increments). Hold either button down for 1 second to change times rapidly. **Up to 9 start times can be programmed for each station number.**

If the start times are the same for any of the stations, these zones will operate simultaneously. If the start times are

unique for each of the stations, any stations that overlap in run times, will be stacked chronologically.

## Eliminating a Start Time

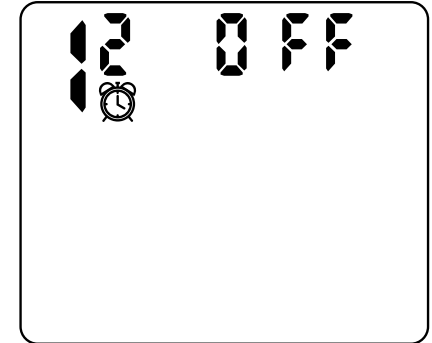
With the display in the watering Start Time mode, push the  or  button until you reach 12:00 AM (midnight). From here push the  button once to reach the OFF position. (For example, the figure to the right indicates that start time number two for station number one is off.)







**NOTE: If a station has all 9 start times turned off, then the station is off.**



**NOTE: When you leave the start time setup, all start times will be re-arranged in chronological order.**

# PROGRAMMING THE WVP (continued) .....

## Setting the Run Time (Length of Watering)



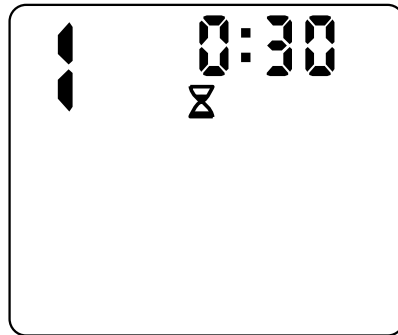

1. Press the  button until the Run Time icon is displayed.
2. The display will show the station number and the last run time entered will be blinking.
3. Use the  or  button to change the station run time on the display from 1 minute to 4 hours.
4. Use the  button to navigate the next station.
5. Repeat steps 3 and 4 for each station.







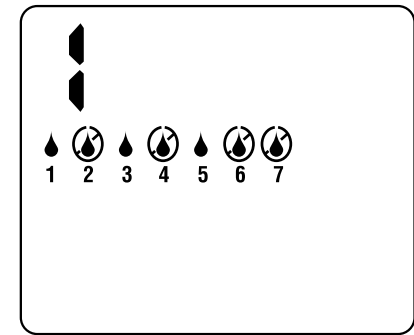

## Setting Days to Water

1. Push the  button until the Water Days icon is displayed.
2. For each station, the WVP will display either specific days to water or interval watering.

## Selecting Specific Days of the Week to Water

For specific day of the week watering, the station number and 7 days of the week with a  icon or a  icon above the numbered day will be displayed. The  icon would represent an “ON” watering day, while the  icon would represent an “OFF” watering day.











1. Press the  button to navigate to the desired station.
2. With the  cursor on a specific day (the cursor always starts with 1), press the  button to activate a particular day of the week to water. Press the  button to cancel watering for that day. After pressing a button the cursor automatically advances to the next day.
3. Repeat step 1 until all desired days have been selected. The selected days will show with a  to indicate their status “ON”. The last  is the last watering day for the program.
4. Repeat steps 1 through 3 for each station.



**NOTE: If specific days of the week watering is selected, make sure the specific days to water mode is displayed prior to navigating to the next station.**

## Selecting Interval Watering

With this option you can select interval watering from 1 to 31 days.

1. Use the  button to navigate to the desired station.
2. With the  cursor on day 7, press the  button once. The interval watering icon  →  will be displayed along with the interval (flashing).
3. Press the  or  button to select the number of days between watering days (1 to 31). This is called the interval. Pressing the  at anytime during the interval setup will advance back to specific days of the week to water.

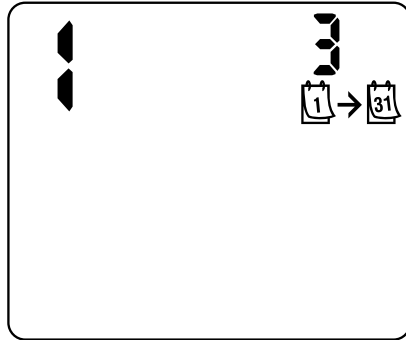





**NOTE: If interval watering is selected, make sure the interval mode is displayed prior to navigating to the next station.**

The controller will water the next Start Time and will then water at the interval programmed.

## System Off

The system off function will turn your WVC controller off, stopping all automatic watering until turned back on with your WVP.

### To turn the WVC off:

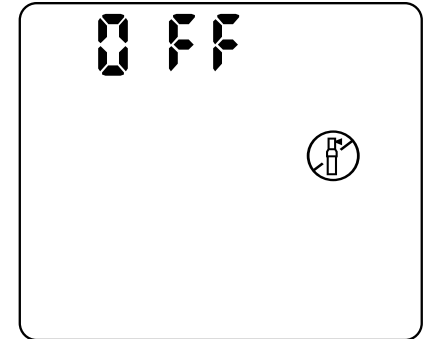

1. Use the  button until the off  icon is displayed. After flashing for a few seconds, the word "OFF" will appear in the display.
2. Squeeze the Transmit/Receive button on the WVP once to move to communication mode (lower part of LCD), use the  and  buttons to make sure the arrow is pointed toward the WVC icon, then squeeze and hold the Transmit/Receive button on the WVP. The WVP will beep twice indicating that the "OFF" command is being



# PROGRAMMING THE WVP (continued) .....

sent to the WVC. It will beep twice again indicating the command was successfully received by the WVC.

## To turn the WVC on:







1. While in the programming mode (upper part of the LCD), press the  button until the current time and day is displayed.
2. Squeeze the Transmit/Receive button once to move to communication mode (lower part of LCD), use the  and  buttons to make sure the arrow is pointed toward the WVC, then squeeze and hold the Transmit/Receive button on the WVP. The WVP will beep twice indicating that the “ON” command has been sent to the WVC. It will beep twice again indicating the command was successfully received by the WVC.

**Tip:** Use the retrieve program function (see page 14) to identify if WVC has been turned off in the field. After retrieving the program, a controller that has been turned off will display the system off  icon on the WVP display.

## Programmable Rain Off

This feature permits the user to stop all programmed waterings for a designated period from 1 to 7 days. At the

end of the programmable rain off period, the controller will resume normal automatic operation.

1. Press the  button until the System Off icon and OFF is displayed.
2. Press the  button and a 1 will be displayed. The 1 will be blinking at this point.
3. Press the  button as many times as needed to set the number of days off desired (up to 7).
4. Press the  button once. The number of days off will stop flashing.
5. Squeeze the Transmit/Receive button once to move to communication mode.
6. Use the  and  buttons to make sure the arrow is pointed towards the WVC indicating Transmit mode.
7. Squeeze and hold the Transmit/Receive button. The WVP will beep twice indicating the command is being sent to the WVC. It will beep twice again to indicate that the WVC has received the command.

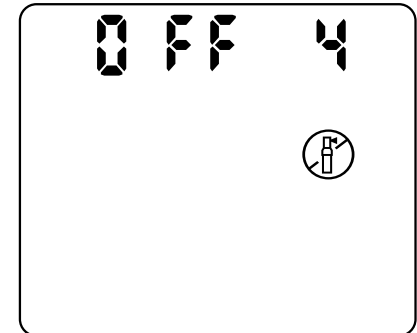

# TRANSMITTING/RECEIVING DATA.....

All program information and manual watering is conducted with the WVP and individual WVC controllers using radio signals. Under normal conditions, these operations can be conducted up to 100 feet from the controller. The Transmit/Receive button on the handle of the WVP is used to establish radio contact to transmit and receive data.

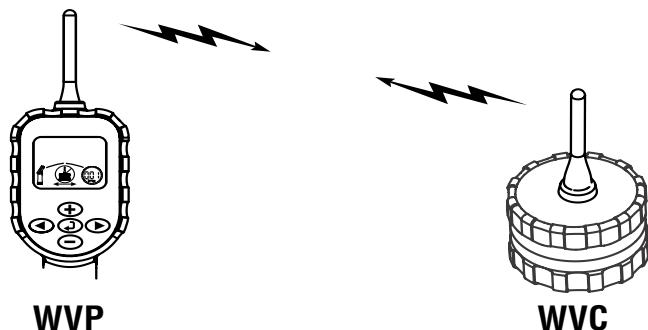

**NOTE: Although you can use the WVP to program multiple WVC controllers, you can only transmit and Receive data to and from one WVC at a time.**

It is recommended procedure to first retrieve the program from a WVC, review and make necessary changes, and then transmit the new program back to the WVC.

## Entering the WVC Identification Code

Each WVC controller has a unique 3-digit identification code that is established during the installation of the controller. This unique code allows for added security and radio operation of individual controllers on a site that has multiple WVC controllers. To establish radio contact with a WVC, you must know the unique identification code that was established during the initial setup of the WVC controller (refer to the WVC Owner's Manual for information on setting or changing the identification code for your controller).

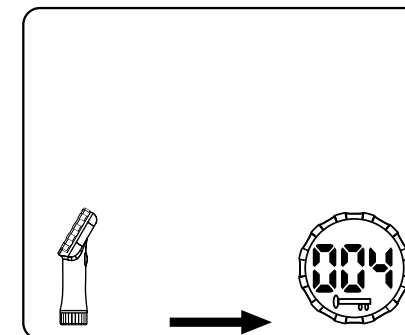

1. Press the Transmit/Receive button on the WVP handle. The lower portion of the display will illuminate. The Transmit/Receive arrow will be flashing.
2. Use the **+** or **-** button to enter the unique WVC identification code from 0 to 999.



# TRANSMITTING/RECEIVING DATA (continued) .....

## Transmitting Programs

Once the WVC 3-digit identification code is entered into the WVP:

1. Use the  button to select the transmit function. (The  arrow will be flashing).
2. Squeeze and hold the Transmit/Receive button on the handle of the WVP for 2 seconds. The WVP will beep twice indicating that communication is taking place.

3. After a few seconds, dashed lines will appear on the display indicating that radio communication is being made with the WVC. When the last dashed line illuminates, data transmission is completed and the WVP will beep twice indicating that data transmission was successful.

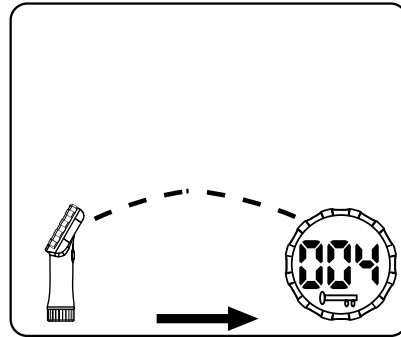

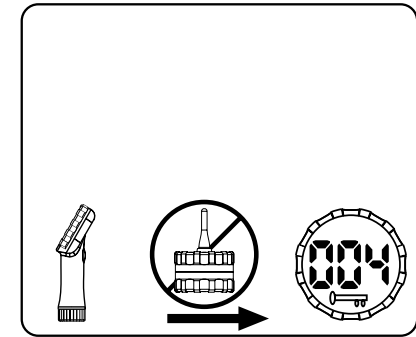

If for any reason if radio connect was not successful, the WVP will produce a single two second beep and the No Contact icon  will be displayed in the middle of the display for a brief period.

If you are experiencing problems contacting the WVC, make sure you are using the correct identification code. If communication problems persist, try moving closer to the WVC to improve radio contact. The range of the signal will be up to 100 ft. with the WVC installed in the valve box. Actual performance varies depending upon the installation and the surrounding terrain.



## Retrieving Programs

Once the WVC 3-digit identification code is entered into the WVP:



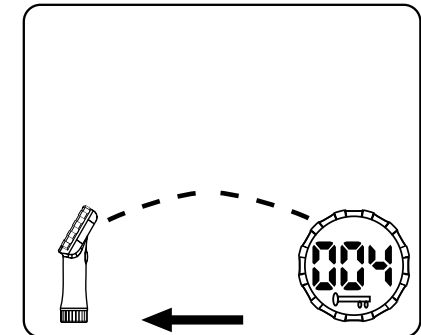

1. Press the  button on the WVP to select the receive function (the  will be flashing).
2. Squeeze and hold the Transmit/Receive button on the handle of the WVP for 2 seconds. The WVP will beep twice indicating that communication is taking place.



3. Dashed lines will appear on the display indicating that radio communication is being made with the WVC. When the last dashed line illuminates, data transmission is completed and the WVP will beep twice indicating that data transmission was successful.
4. All current program information and battery life status from the WVC can now be reviewed with the WVP by squeezing the transmit/receive button once, which returns the unit to programming mode.

## Manual Watering Operation

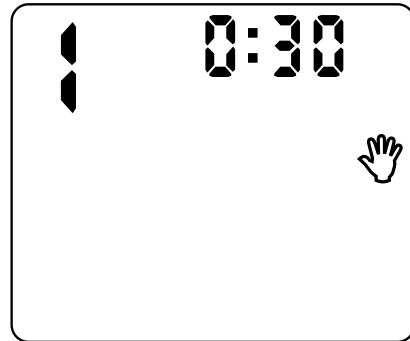

To activate a Manual Watering:

1. With the current time/day showing in the display press and hold the  button to display the Manual Watering icon. The station number will also be displayed.
2. Use the  button to navigate to the station that you would like to manually activate.
3. Use the  or  button to adjust the manual water run time from 1 minute to 4 hours.



4. While in the Manual Watering mode, squeeze and hold the Transmit/Receive button for 2 seconds to initiate the manual watering cycle.
5. Repeat step 1 through 4 to manually activate additional stations.

To suspend Manual Watering:

1. With the current time/day showing in the display, press and hold the  button to enter the manual off mode.
2. Use the  button to navigate to the station you would like to turn off.
3. While in the manual off mode, squeeze and hold the Transmit/Receive button for 2 seconds to deactivate the manual cycle for the station selected.
4. Repeat steps 1 through 3 to turn off additional stations.

# BATTERY LIFE INDICATOR .....

The battery life indicator icon is a quick way to determine the remaining life of the battery installed in any individual WVC controllers. The WVP will retrieve the battery life information from the WVC when programs are retrieved (see Retrieving Programs). A fully charged battery will show all three segment of the battery dark. As the battery is expended, the segments will appear as outlines.



**Fully Charged**

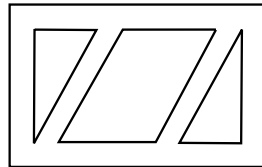

**Battery Low**

After retrieving battery life information from the WVC, the battery life indicator will display the WVC information until the WVP LCD goes blank due to inactivity. The next time the WVP display comes on it will provide battery life information for the battery in the WVP.

# **TROUBLESHOOTING GUIDE .....**

<b>Problem</b>	<b>Causes</b>	<b>Solutions</b>
<b>No display on WVP.</b>	Display is off. Battery is dead.	Press any button for 1 second. Replace battery.
<b>Automatic irrigation does not start at start time.</b>	Controller in System Off mode. AM/PM of time of day not set correctly. AM/PM of start time not set correctly. Faulty wire connection(s) at solenoid.	Re-enable watering (see pg.12). Correct AM/PM of time of day. Correct AM/PM of start time. Recheck wiring to solenoid.
<b>Rain sensor does not suspend watering.</b>	Rain sensor defective or miswired.	Verify proper operation of the rain sensor and wire connections.
<b>Controller waters more than one time.</b>	Too many start times have been entered.	Recheck start times.

## **TROUBLESHOOTING GUIDE (continued) .....**

<b>Problem</b>	<b>Causes</b>	<b>Solutions</b>
<b>No contact icon is displayed when transmitting or receiving data.</b>	Wrong 3-digit WVC identification code entered.  Out of range.  Battery dead in WVC.	Reenter correct identification code in WVP. (Reference WVC owner's manual for establishing WVC I.D.)  Move closer to WVC and attempt to establish contact.  Replace WVC battery.

## **FCC NOTICE**.....

This notice applies only to model WVP

### **FCC ID: M3UWVP**

This equipment has been tested and found to comply with the limits for class B digital device, pursuant to part 15 of the FCC Rules. These limits are designed to provide reasonable protection against harmful interference in a residential installation. This equipment generates, uses and can radiate radio frequency energy and if not installed and used in accordance with the instructions, may cause harmful interference to radio communications. However, there is no guarantee that interference will not occur in a particular installation. If this equipment does cause harmful interference to radio or television reception, which can be determined by turning the equipment off and on, the user is encouraged to try to correct the interference by one or more of the following measures:

- Reorient or relocate the receiving antenna
- Increase the separation between the equipment and the antenna
- Consult the dealer or an experienced radio/TV technician for help

The user is cautioned that changes and modifications made to the equipment without the approval of the manufacturer could void the user's authority to operate this equipment.

# INDUSTRY OF CANADA NOTICE .....

This notice applies only to model WVP

## IC: 2772 – WVP

The term “IC:” before the certification/registration number only signifies that the Industry of Canada technical specifications were met.

Operation is subject to the following two conditions: (1) this device may not cause interference, and (2) this device must accept any interference, including interference that may cause undesired operation of the device.

# CE NOTICE.....

<b>CE Notice: this notice applies only to model WVP-E</b>				
		<b>Important Notice:</b> Low power RF product operating in 869.700-870.000MHz band for indoor or outdoor home and commercial use.		
		Member states in the EU with restrictive use for this product are crossed out.		
AUS	B	DK	FIN	
F	D	<del>GR</del>	IRE	
I	LUX	NL	P	
E	S	UK		

